

# LWL Series

## ▶ Optical Fibers Attachment Optics

Optical fibers offer solutions for difficult tasks in optoelectronics. They can be used universally and allow flexible applications.

- Highest quality
- Selection from different fiber types
- Thermal stability
- Great variety of available standard sensor heads
- Special designs



## Characteristics

Light-conducting glass fibers are optical components that allow the transmission of light through any curved path based on the principle of total reflection.

The individual fiber is composed of high-break core glass and low-break cladding glass. The light beams entering the core glass within the critical angle are guided through the fiber by way of reflection at the core/cladding contact surfaces (step index fiber).

The highly flexible optical fibers are made of bundled individual glass fibers. The ends are each glued into a sensor head and a connector. The faces are optically polished. For protection against mechanical, chemical, or thermal destruction the optical fibers are provided with a corresponding protective sheath.

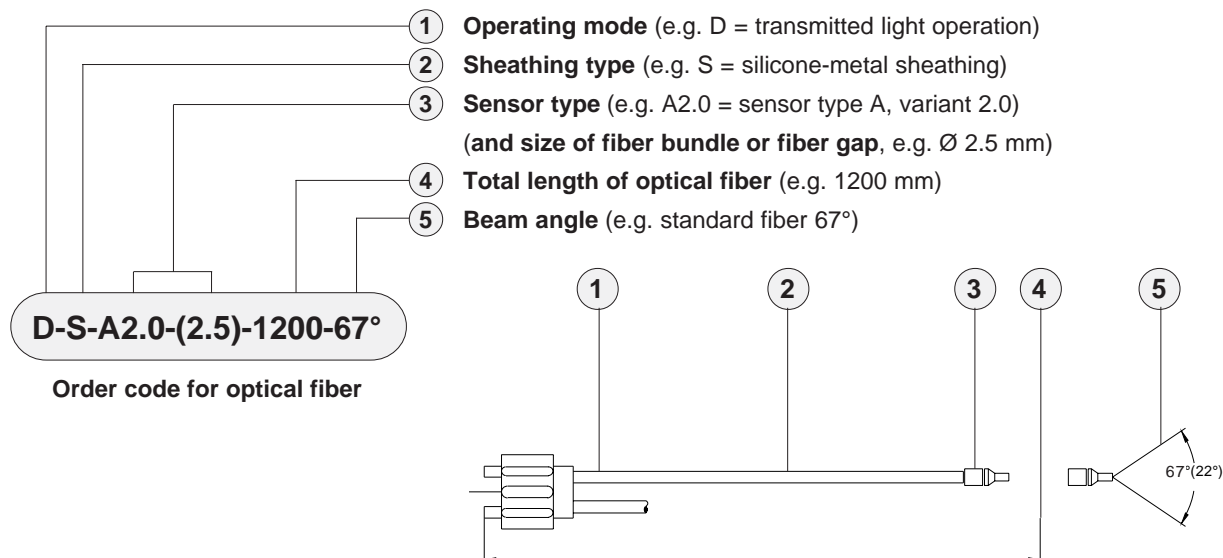

### Dimensions of adaptor

**Attachment optics** (e.g. prism optics, reflex optics, focus lense)

**Overview: Optical fibers with reflected light operation**

**Overview: Optical fibers with transmitted light operation**

**Special optical fibers, mounting of optical fibers**



Fiber Optics

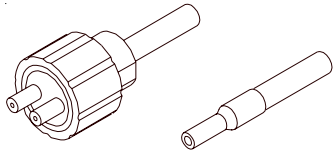

R-P-A2.0-(2.5)-...

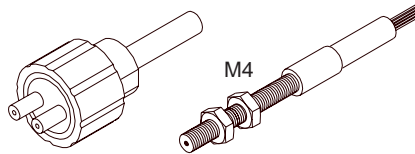

R-S-C1.0-(1.0)-...

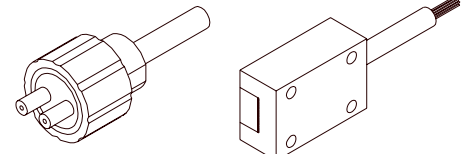

R-S-Q2-(10x0.3)-...

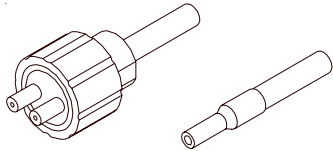

R-S-A2.0-(2.5)-...

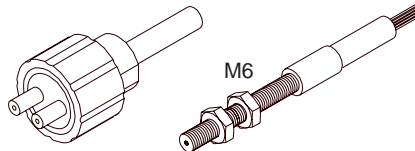

R-S-C2.0-(2.5)-...

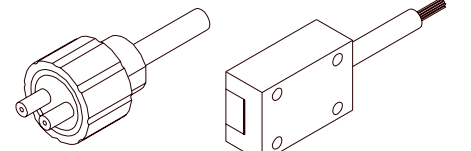

R-S-Q3-(18x0.3)-...

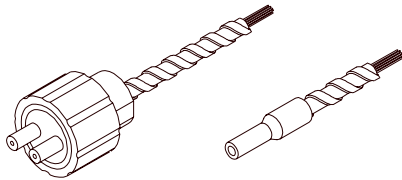

R-E-A2.0-(2.5)-...

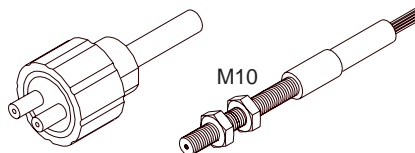

R-S-C3.0-(3.0)-...

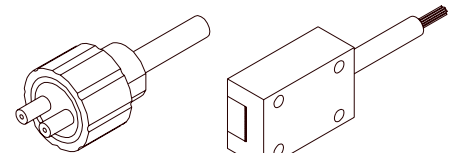

R-S-Q4-(28x0.2)-...

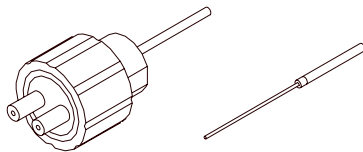

R-P-B1.1-(0.6)-...

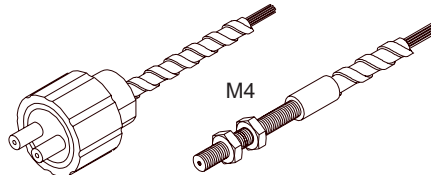

R-E-C1.0-(1.0)-...

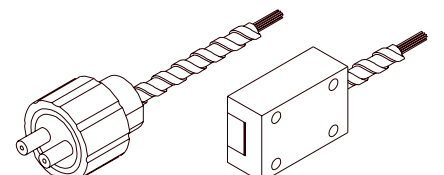

R-M-Q2-(10x0.3)-...

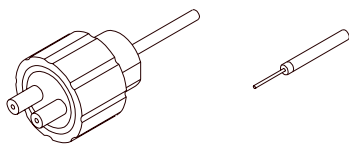

R-P-B2.0-(1.0)-...

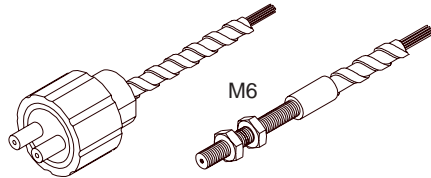

R-E-C2.0-(2.5)-...

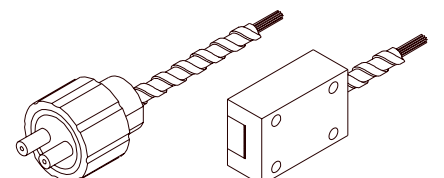

R-M-Q3-(18x0.3)-...

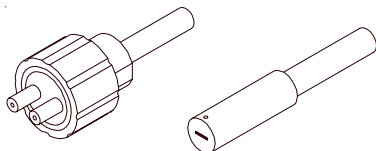

R-S-R1.1-(3x0.5)-...

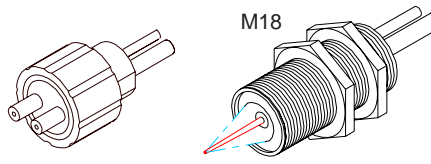

R-P-M18-(25)-...

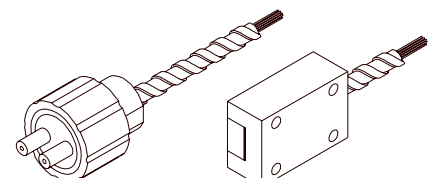

R-M-Q4-(28x0.2)-...

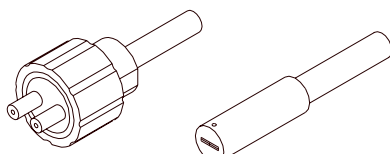

R-S-R2.1-(6x1)-...

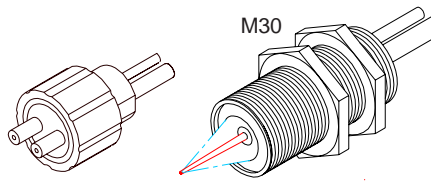

R-P-M30-(30)-...

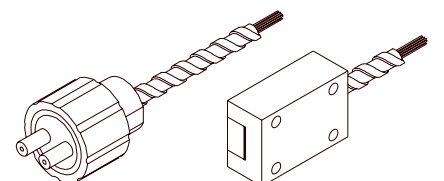

R-E-Q2-(10x0.3)-...

Fiber Optics

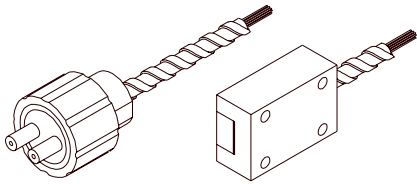

R-E-Q3-(18x0.3)-...

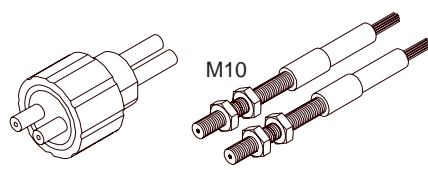

D-S-C3.0-(3.0)-...

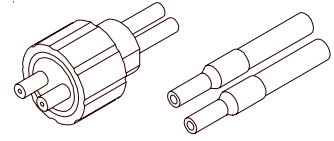

D-S-A2.0-(2.5)-...

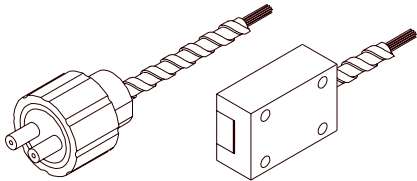

R-E-Q4-(28x0.2)-...

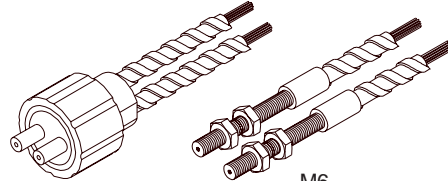

D-E-C2.0-(2.5)-...

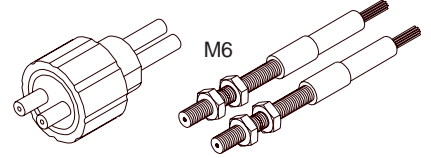

D-S-C2.0-(2.5)-...

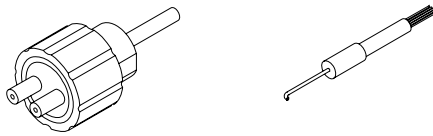

R-S-D1.1-(0.6)-...

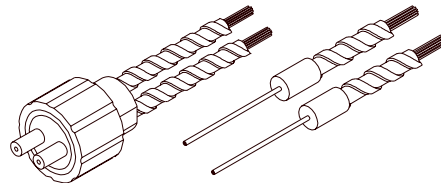

D-M-M1.1-(0.6)-...

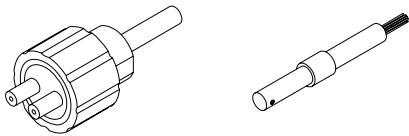

R-S-F1.0-(1.5)-...

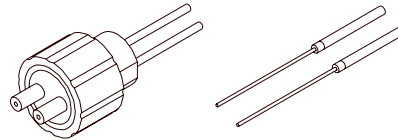

D-P-B1.1-(0.6)-...

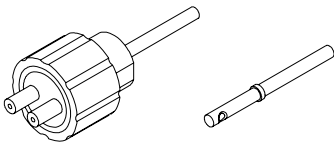

R-P-E1.0-(1.5)-...

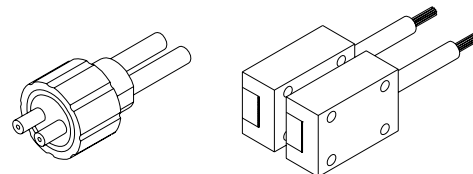

D-S-Q4-(28x0.2)-...

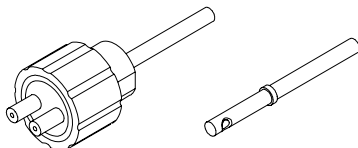

R-P-E2.0-(2.5)-...

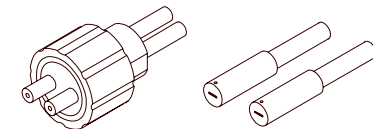

D-S-R1.1-(3x0.75)-...

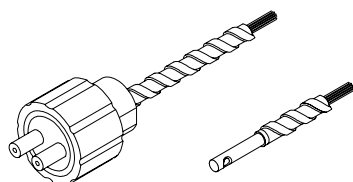

R-M-E2.0-(2.5)-...

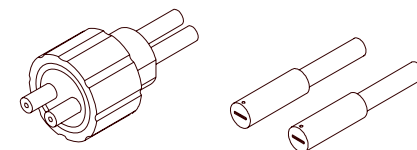

D-S-R2.1-(6x1)-...

Attachment Optics

