

R-LAS Series

▶ Product Information

The laser reflection light barriers of the R-LAS-LR series operate according to the principle of auto-collimation. An integrated polarisation filter ensures protection against spurious triggering caused by reflecting objects. The laser power adjusts itself to the respective reflector and reflector distance. Parameterisable under Windows® with Sensor Instruments software LR-SCOPE.

The laser light sensors of the R-LAS-LT series operate according to the principle of triangulation with background suppression. The measuring object is measured independently of the surface quality, color, and background. Standardised evaluation and automatic power correction ensure a very dynamic range. Parameterisable under Windows® with Sensor Instruments software RT-SCOPE or LT-Scope.

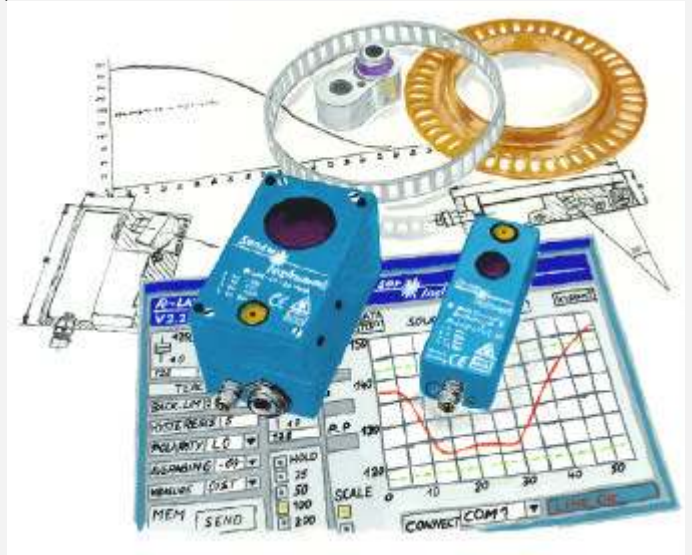

Characteristics

Parameterisable under Windows®

Sensor parameters such as tolerance, laser power, switching hysteresis, bright/dark-switching, automatic laser power correction on/off, averaging, intensity/distance selection can be set through the RS232 interface.

With sensors of type R-LAS-LT the two analog signals or the standardised signal can be displayed on the PC. The Software RT-Scope, LT-Scope, or LR-Scope is included with product.

High positioning accuracy

The laser light sensors of type R-LAS-LT above all are characterised by their high positioning accuracy. The extremely small laser spot (40 µm diameter at reference distance) allows the measurement of very small objects, such as for example IC pins or threads. Various types with different reference distances are available: 45 mm, 80 mm, 110 mm, 170 mm, 300 mm, 500 mm, 900 mm.

The reflection light barriers of type R-LAS-LR are excellently suited for the detection of small objects due to the very small laser beam diameter (approx. 2mm). With the R-LAS-LR-R type a triple mirror serves as a reflector, whereas with the R-LAS-LR-O version the object itself acts as a reflector.

Distance checking by way of tolerance setting

Apart from high-accuracy positioning tasks the R-LAS-LT types can also be used for distance monitoring tasks. Under Windows® the tolerance band is set symmetrically around the reference distance.

High switching frequency

Scanning of small objects or of objects moving at high speed requires a high switching frequency. With a switching frequency of 6 kHz with the R-LAS-LR types and 3 kHz with the R-LAS-LT types the R-LAS Series is well suited for high speed processes.

Adjustable time delay

Under Windows® a time delay (pulse lengthening) can be set in steps from 0 ms to max. 200 ms.

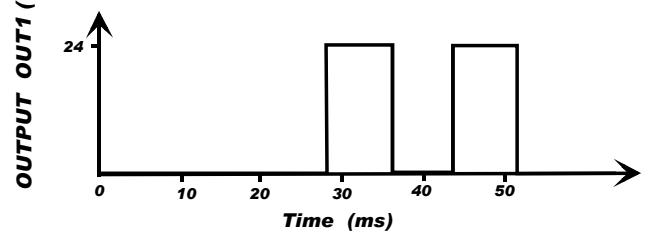
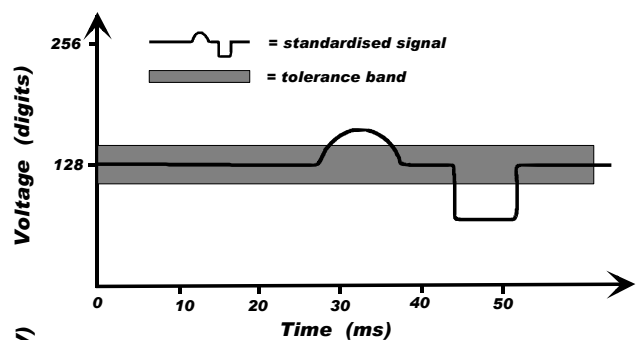
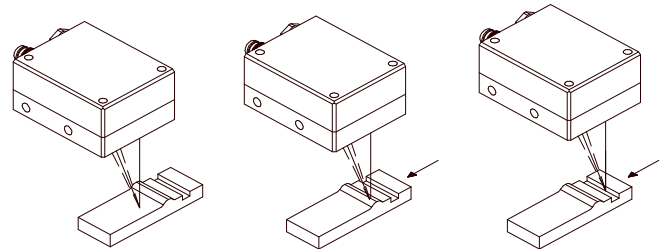

If the standardised signal (distance signal) leaves the tolerance band, an error is indicated at the tolerance switching output.

Characteristics

Position checking

With its very small laser spot the sensor type R-LAS-LT is ideally suited for positioning tasks. Since the sensor operates according to the triangulation principle, the background can be easily suppressed.

Horizontal positioning:

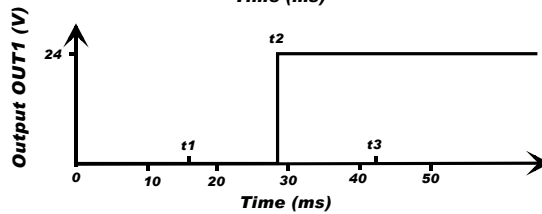
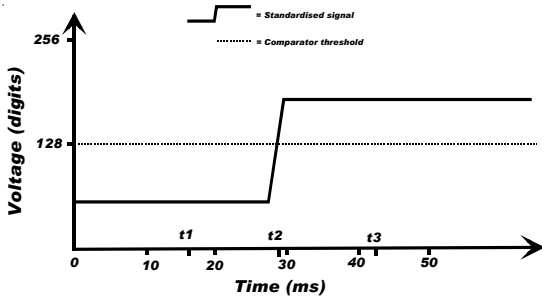
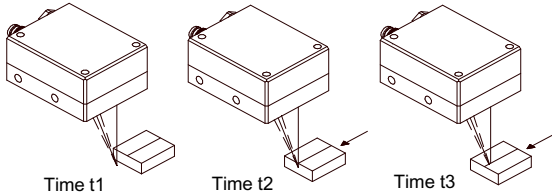

Vertical positioning:

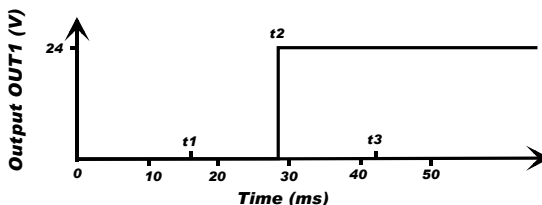
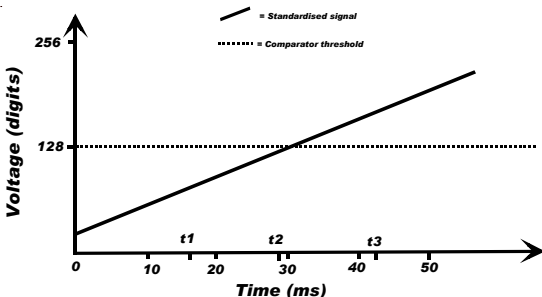
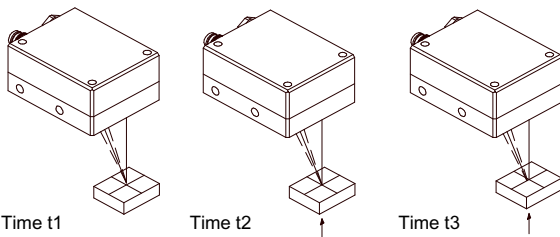

Pulsating light operation

In addition to optical filtering the insensitivity to outside light of the R-LAS sensors and light barriers is further increased by pulsating operation. The R-LAS-LT types are pulse-operated with approx. 200 kHz, and the R-LAS-LR types with approx. 50 kHz.

Polarisation filter

The polarisation filter that is integrated in the R-LAS-LR-R types suppresses spurious triggering caused by reflections at the measuring object. Even parts with very good reflection behaviour, such as nickel-plated or chromium-plated objects, can be safely measured.

Autocollimation principle

The light barriers of type R-LAS-LR operate according to the autocollimation principle, i.e. transmitter and receiver are set to the same optical axis. This allows safe detection of measuring objects starting from a distance of approx. 1mm from the face of the sensor housing.

Automatic laser power correction

In the sensors of type R-LAS-LT the laser light ratio that is directed into the optical receiver by the measuring object is kept constant, i.e. the laser power is increased in case of highly absorbing objects, while in case of measuring objects with highly scattering surfaces (e.g. white paper) the laser power is reduced.

The degree of absorption and the surface properties of the measuring object thus to a large extent have no influence on the measuring accuracy.

Automatic laser power correction with the R-LAS-LR types operates in a similar way. With the R-LAS-LR-R the laser power adjusts itself to the respective reflector and reflector distance in such a way that laser power arriving at the receiver is kept constant.

The R-LAS-LR-O tries to correct the laser power and adjust itself to the respective background with a certain time constant.

Due to this automatic laser power correction the receiver is actively kept in the dynamic range and is not brought to saturation status, which considerably contributes to increased sensitivity. With the R-LAS-LR-R version this allows safe detection of objects starting from 0.1mm.

Background suppression

The laser sensors of R-LAS-LT type operate according to the triangulation principle. A specially adapted differential diode acts as a receiver, i.e. the laser spot is projected onto a receiver diode over a wide distance range. Around the reference distance ($\pm 3\text{mm}$) the laser spot is directed onto both photodiodes, which is used for distance checking.

Insensitive to outside light

The influence of outside light is considerably reduced by means of a red light filter and an additional interference filter. With the R-LAS-LR-R the integrated polarisation filter also reduces the effect of outside light.

Characteristics

High sensitivity due to threshold correction

With the R-LAS-LR types the switching threshold is dynamically corrected by way of constant monitoring of the maximum value at the receiver in order to avoid losses of sensitivity or trigger point shifting. In conventional reflection light barriers the switching threshold, which depends on a fixed, absolute voltage, is set by means of a potentiometer. In case of increasing dirt accumulation this leads to a shift of the switching point.

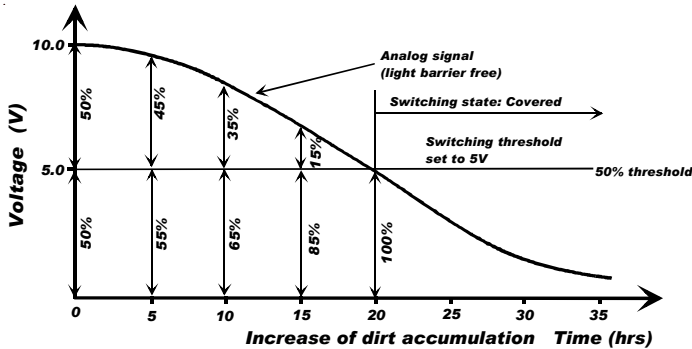

Example:

The switching threshold is set to a fixed value of 5V, which in case of a 10V analog signal (without dirt accumulation and covering) leads to a change of the switching point at 50% light spot covering. The analog signal decreases with increasing dirt accumulation, while the switching threshold remains constant. This means that the light spot no longer needs to be covered by 50% to cause switching of the light barrier.

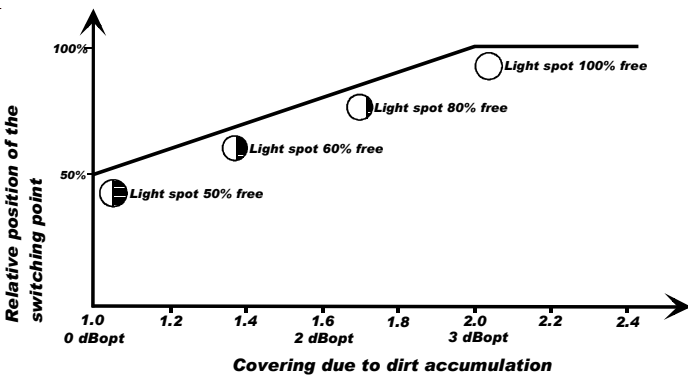

By way of continuous monitoring of the maximum value at the receiver a dynamic correction of the switching threshold compensates the effect of dirt accumulation. This means that increased dirt accumulation does not lead to a shift of the switching point.

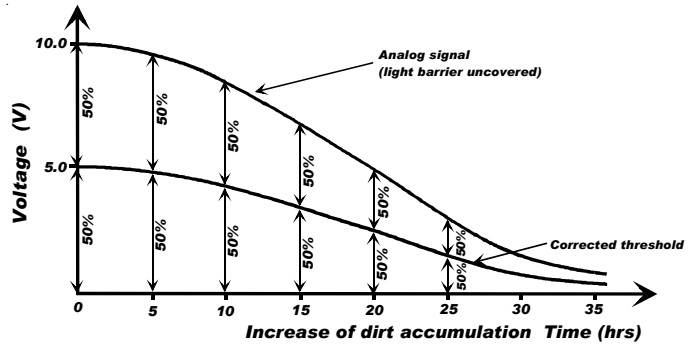

Example:

In clean condition the laser reflection light barriers of type R-LAS-LR show a bit value of 255, the switching threshold adjusts itself to 50% of this bit value (parameterisable), i.e. the switching status changes at 50% covering of the light spot. In case of increasing dirt accumulation the value of the digitised receiver signal decreases, but the 50% distance to the switching threshold is maintained.

Compact and sturdy metal housing

With their sturdy metal housing and their high type of protection the laser sensors and light barriers of R-LAS Series are designed for demanding applications in machine construction.

Optics and optics cover made of glass

Scratch resistant filter glass guarantees reliable long time operation also in rough industrial applications.

Visible red laser spot

The visible red light beam considerably facilitates correct alignment of the sensors and light barrier of R-LAS Series to the measuring object or to the reflector.

Modular design - repairable

In case of possible damaging of mechanical or electronic components during operation individual components can be replaced due to the modular design of the R-LAS Series (sensor top part can be unscrewed). Costly replacement can thus be avoided in most cases.

Analog output

As an alternative to the digital outputs (tolerance and reference) there is with the option -ANA an analog output (0V ... +10V) available for measuring purposes.

Product Line

R-LAS-LT-45

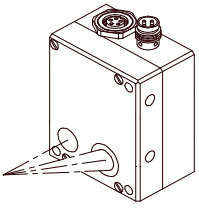

R-LAS-LT-80

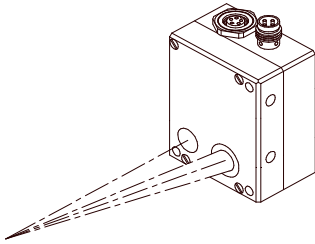

R-LAS-LT-80-WA

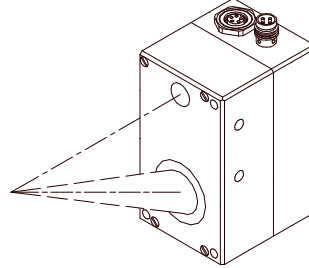

R-LAS-LT-170

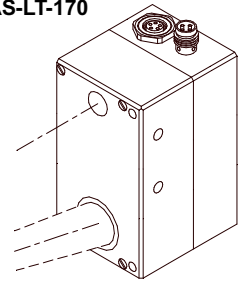

R-LAS-LT-300

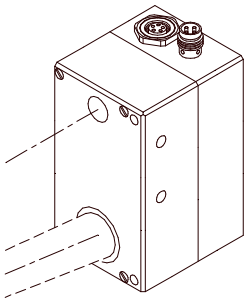

R-LAS-LT-500

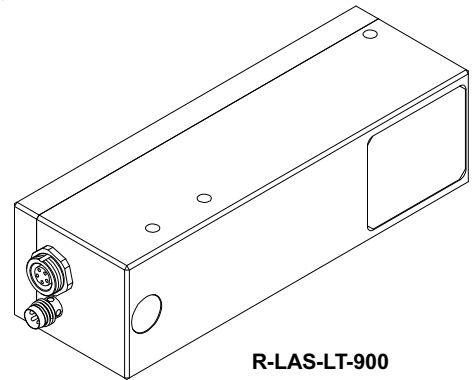
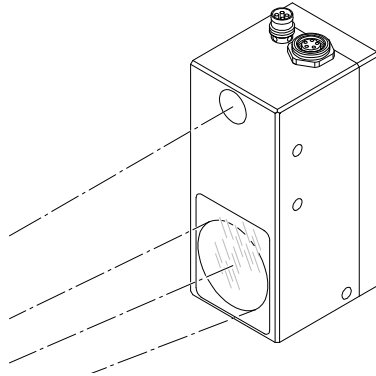

R-LAS-LT-900

R-LAS-LR-R

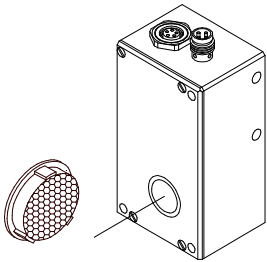

R-LAS-LR-O

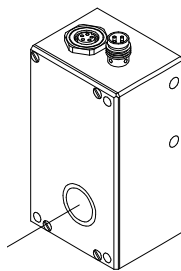

R-LAS-LT-45-HR
R-LAS-LT-120-HR
R-LAS-LT-45-WR
R-LAS-LT-120-WR

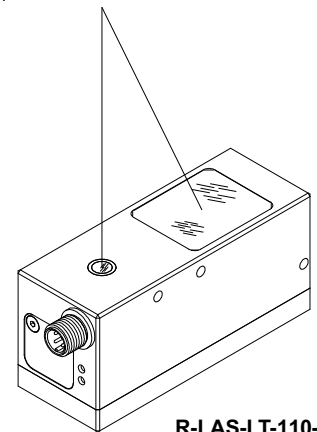
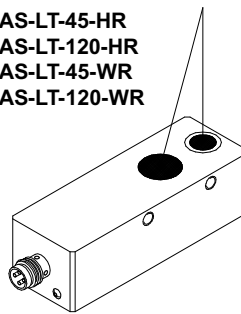

R-LAS-LT-110-HD2
R-LAS-LT-110-HD2-ANA

R-LAS-LR-RP

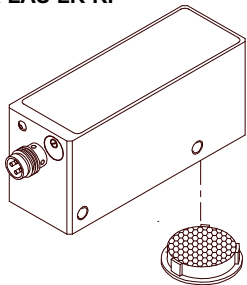

R-LAS-LR-OP

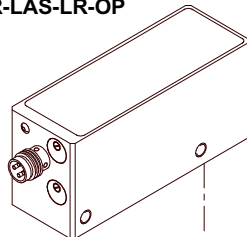

R-LAS-GD1

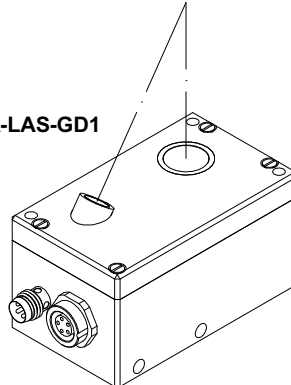

R-LAS-GD2

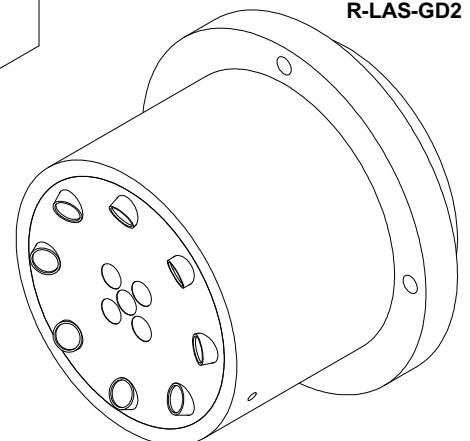

R-LAS-LR-O-LWL

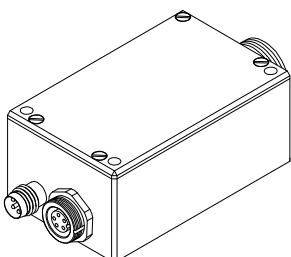

R-LAS-LR-O-LWL-TE-HAMP

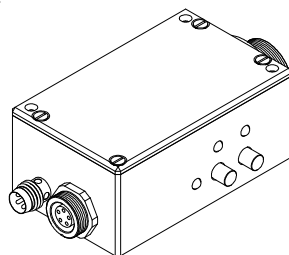

R-LAS-LR-OBC

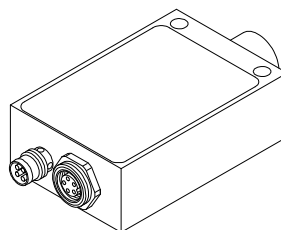

Application Examples

Application example:

The automobile industry often faces the task of positioning on already painted car body components (as a rule with a robot). For this purpose, the distance or the edge between robot and body component must be detected with an accuracy of only a few tenths. Because of the different paint finishes (from black to white), the dynamic range of the employed laser sensor has to meet highest demands.

By means of automatic laser power correction, the R-LAS-LT-110-HD2 laser reflex sensor adapts itself almost without any problems to the respective surface, which means that bright and dark objects can be detected with highest accuracy.

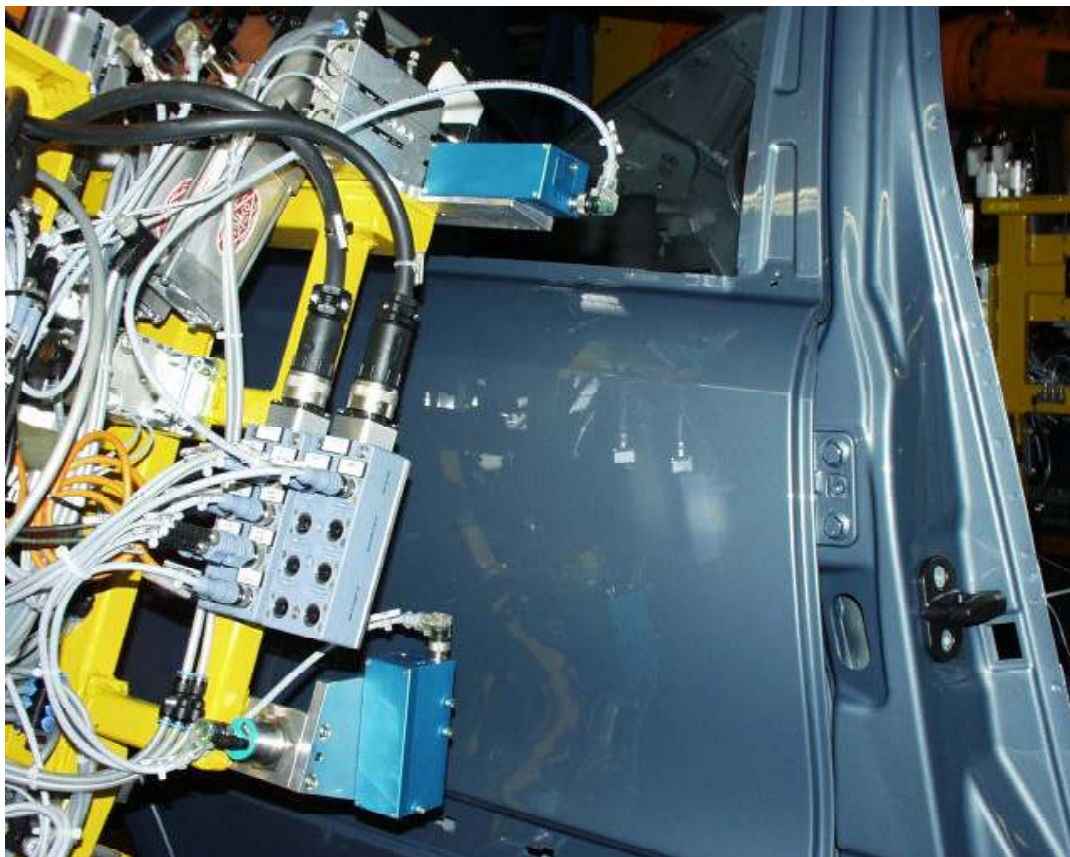
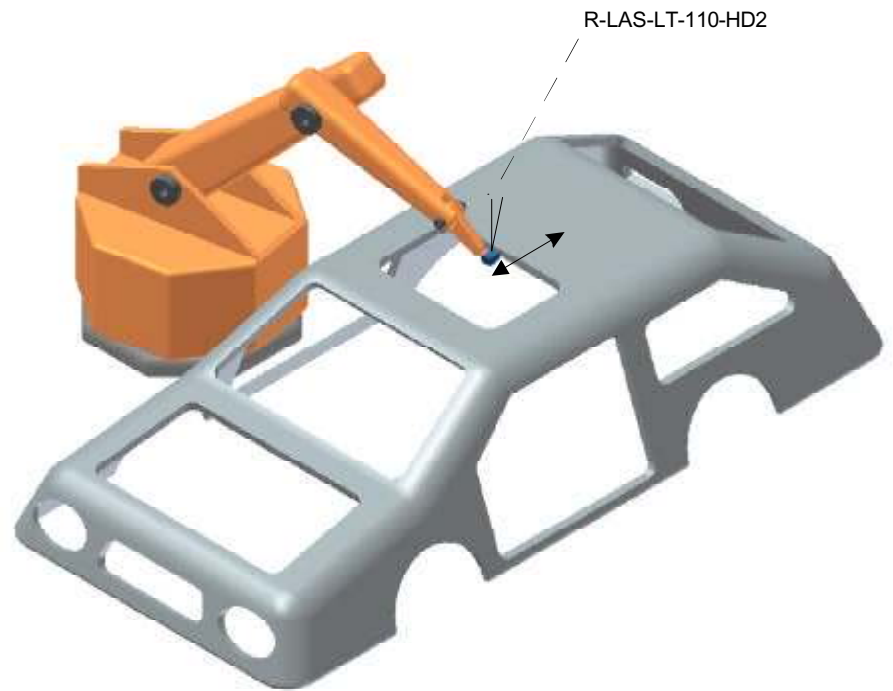
R-LAS-LT-110-HD2

**Application Examples****Checking the position of anchor rods**

In this application it must be checked whether the short end or the long blank end of the anchor rod lies in the infeed of the machine.

The gloss sensor R-LAS-GD1 is directed onto the surface of the anchor rod in such a way that the laser spot in case of the short blank end impinges on the cross-knurled surface, whereas in case of the long blank end the laser spot impinges on the blank surface.

When there is a blank surface, more laser light reaches the receiver that is arranged coaxially to the laser transmitter, whereas only little light reaches the receiver that is arranged at an angle to the laser transmitter.

When there is a cross-knurled surface, however, the laser light is scattered into the complete half space, which leads to an increase of the quantity of light in the direction of the receiver that is arranged at an angle, whereas the quantity of light that is detected by the coaxial receiver decreases.

R-LAS-GD1

**Application Examples****R-LAS-GD2****Differentiation of different types of imitation leather of same color but with different surface**

Among other applications, imitation leather is used in the interior of cars for dashboard trimming. A gloss sensor which, due to the rotationally symmetric arrangement of its receivers (2 detector rings) allows intensity-independent (standardised) evaluation, is used to differentiate equal color, but different reflection behaviours. This sensor makes it possible to even detect slightest differences in reflection.



**Application Examples****R-LAS-LR-OBC****Drill fracture control**

Due to the small laser spot diameter of 100 µm at a working distance of 70 mm even very small drills can be detected.

Advantage:

No complicated adjustment to the various drills or milling cutters.

The sensor delivers a digital output signal, which indicates a drill fracture, moreover an additional analog signal (0V ... +10V) can be used for further evaluation purposes.



Laser light barrier R-LAS-LR-OBC mounted at drill head