

SI-COLO Series

▶ SI-COLO3-500 (12 bit A/D conversion)

- Measuring range typ. 50 mm ... 800 mm
- Up to 15 colors can be stored
- RS232 - interface (USB-adaptor available)
- White-light LED, 100 kHz modulated
- Color and gray scale detection
- Brightness correction can be activated
- Several teach-functions (via PC, PLC, or push button)
- Various evaluation algorithms can be activated
- Switching state display by means of 4 yellow LEDs
- Insensitive to outside light
- 'Averaging' can be activated (from 1 up to over 32000 values)

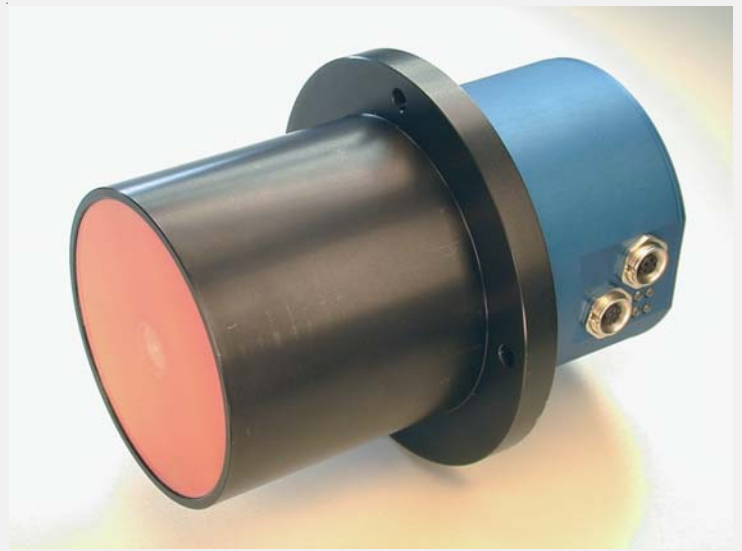

Design

Product name:

SI-COLO3-500-d2

SI-COLO3-500-d2-TC (True Color)

SI-COLO3-500-d3

SI-COLO3-500-d3-TC (True Color)

(incl. software COLOR3-Scope)

d2 = Light spot diameter Ø 23 mm (typ.) at 500 mm distance

d3 = Light spot diameter Ø 50 mm (typ.) at 500 mm distance

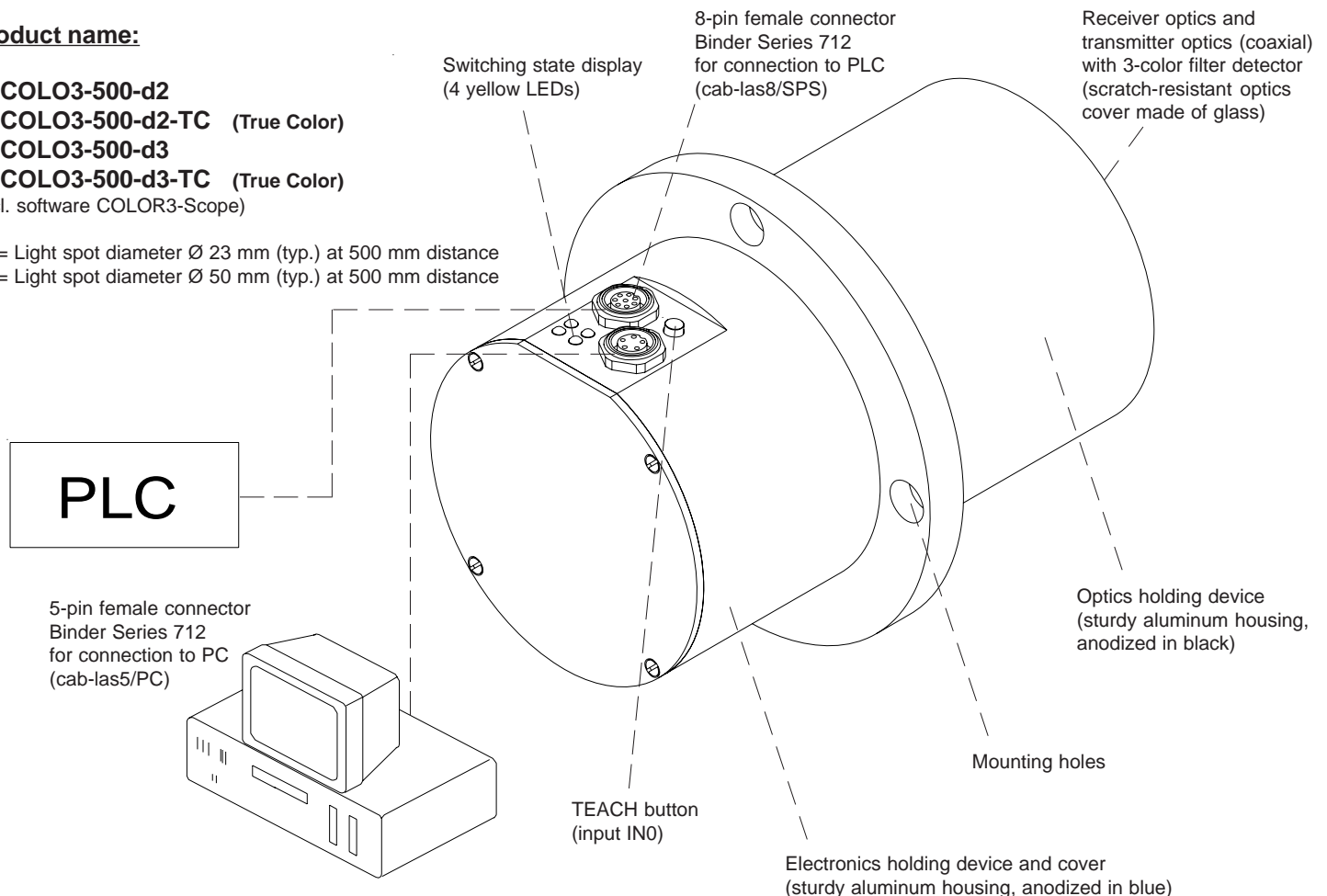

Parameterization under Windows® with software COLOR3-Scope:

The reflex color sensor SI-COLO3-500 can be parameterized via serial interface (RS232) under Windows® (please cf. pages 4-6). Up to 15 colors can be taught, and stored in the sensor. If the sensor detects one of the taught colors, a change of switching state is performed through 4 encoded digital outputs (visual display by means of 4 yellow LEDs at the housing).



Technical Data

Model	SI-COLO3-500-...
Light source	White-light LED, modulated 100 kHz
Target distance	Type d2: typ. 200 mm ... 600 mm Type d3: typ. 50 mm ... 800 mm
Light spot size	Type d2: typ. 23 mm in diameter at 500 mm distance Type d3: typ. 50 mm in diameter at 500 mm distance
Reproducibility	In the X,Y color range 1 digit each at 12 bit A/D conversion
Receiver	3-color filter detector (in case of model "-TC": TRUE COLOR)
Pulsating light operation	100 kHz
Ambient light	Up to 5000 Lux
Type of protection	IP64
Current consumption	typ. 180 mA
Interface	RS232, parameterizable under Windows®
Connector type	Connection to PLC: 8-pin female connector (Binder Series 712) Connection to PC: 5-pin female connector (Binder Series 712)
EMC test acc. to	IEC - 801...
Housing material	Aluminum, anodized in blue or in black
Operating temperature range	-20°C ... +55°C
Storage temperature range	-20°C ... +85°C
Pulse lengthening	Adjustable under Windows® 0 ms ... 100 ms
Max. switching current	100 mA, short-circuit-proof
Switching frequency	Max. 1,6 kHz with 15 teach-in colors, max. 11,5 kHz with 1 teach-in color, max. 95 kHz with contrast detection
Outputs	OUT 0 ... OUT 3
Averaging	Over 32768 values max.
Voltage supply	+12VDC ... +30VDC, protected against polarity reversal, overload-protected
Switching state display	Visualization by means of 4 yellow LEDs
Color memory capacity	non-volatile EEPROM with parameter sets for 15 colors max.
TEACH button	for external teaching of color references via input IN0
Temperature drift X,Y	$\Delta X/\Delta T; \Delta Y/\Delta T$ typ. 0,3 digits/°C (< 0,01% / °C)

Dimensions

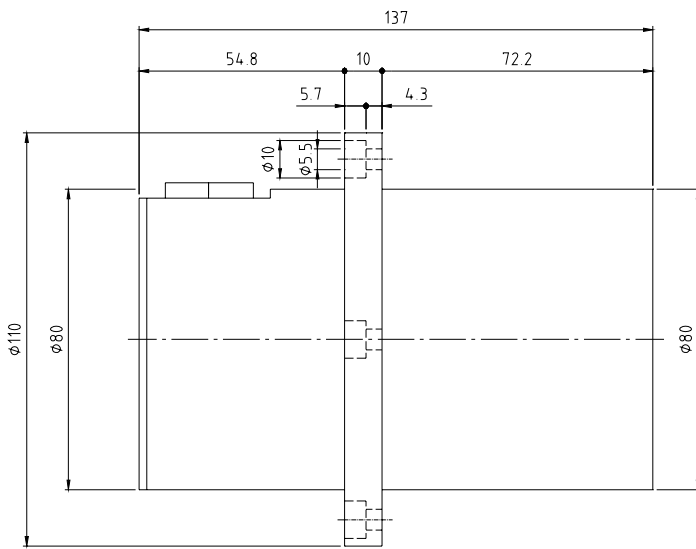

All dimensions in mm

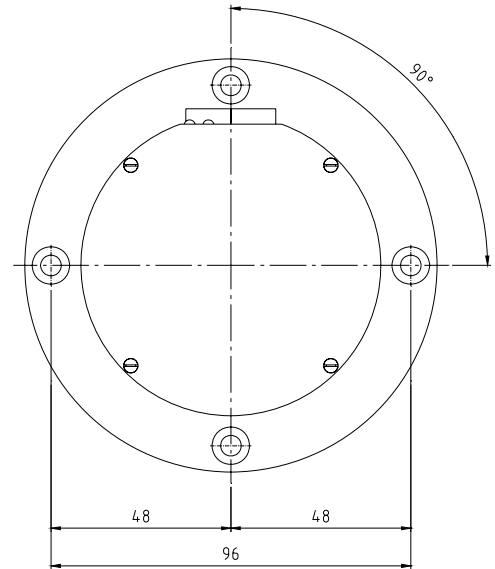

Connector Assignment

Connection of SI-COLO3-500 to PLC:

8-pole female connector Binder Series 712

Pin:	Color:	Assignment:
1	wht	GND (0V)
2	brn	+12 ... +30VDC
3	grn	IN0
4	yel	OUT0
5	gry	OUT1
6	pnk	OUT2
7	blu	OUT3
8	red	n.c.

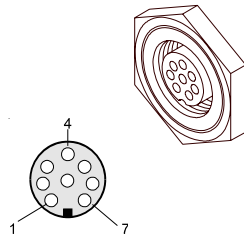

Connection of SI-COLO3-500 to PC:

5-pole female connector Binder Series 712

Pin:	Assignment:
1	GND (0V)
2	TX0
3	RX0
4	n.c.
5	n.c.

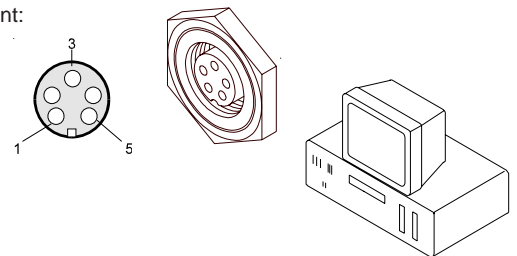

Connecting cables for SI-COLO3-500:

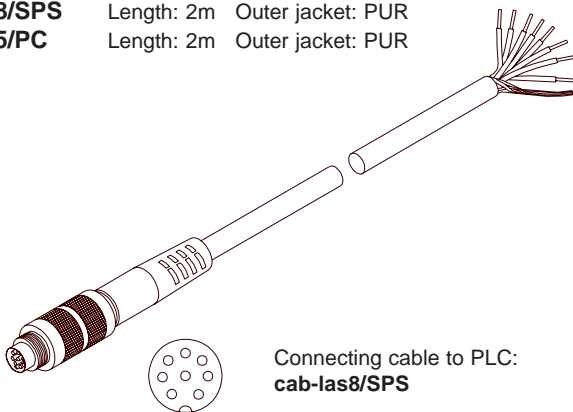

cab-las8/SPS Length: 2m Outer jacket: PUR
cab-las5/PC Length: 2m Outer jacket: PUR

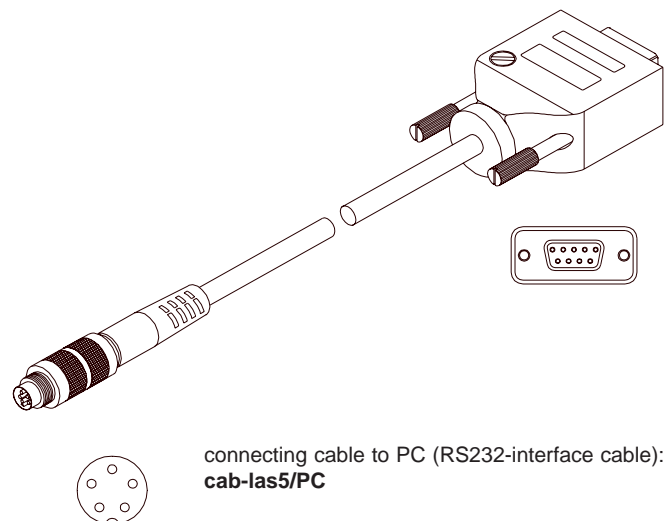

Connecting cable to PLC:
cab-las8/SPS



connecting cable to PC (RS232-interface cable):
cab-las5/PC



Measuring Principle
Measuring principle:

Through an optical transmission unit a modulated white-light LED projects a white-light spot onto a surface to be checked. Through an optical receiver unit part of the light that is reflected from the target is then directed onto a color-sensitive detector element. The received light is separated according to the 3-color-range process (red, green, blue).



Parameterization
Parameterization under Windows® with software COLOR3-Scope:

The color sensor is parameterized under Windows® with the COLOR3-Scope software. The RS232 interface is used for setting parameters such as:

- Averaging over a maximum of 32768 values
- Number of colors to be checked
- Light power of the white-light LED
- Automatic light power control ON/OFF
- Pulse lengthening up to 100ms max.
- External or continuous trigger
- Minimum intensity required for color evaluation

Visualization:

Under Windows® representation of the color value on a PC in numeric form and in a color chart, and representation of RGB values in a time chart. In addition the current RGB values are displayed as a bar chart.

The following evaluation algorithms can also be selected:

- Target lies within the color tolerance circle of a taught color and within an intensity window (FIRST HIT)
- Determination of the taught color that is most similar to the target (minimum distance between target color and reference color in the color chart) (MINIMAL DIST)
- Contrast check of the target. In this case only one primary color (freely selectable) is used for evaluation (CONTRAST)
Advantage: Possibility of using a very high scanning rate.
- EXTERN TEACH: With this function field the color sensor can be taught by means of a LOW-signal at pin 3 (for instance via push button, or PLC). During this procedure the object to be taught has to be in the visibility range of the color sensor. The yellow LEDs indicate a successful teaching procedure.

LED-Display:

The color code is visualized by means of 4 yellow LEDs at the housing of the color sensor. At the same time the color code indicated at the LED display is output as 4-bit binary information at the digital outputs OUT0 to OUT3 of the 8-pin SI-COLO/PLC connector.

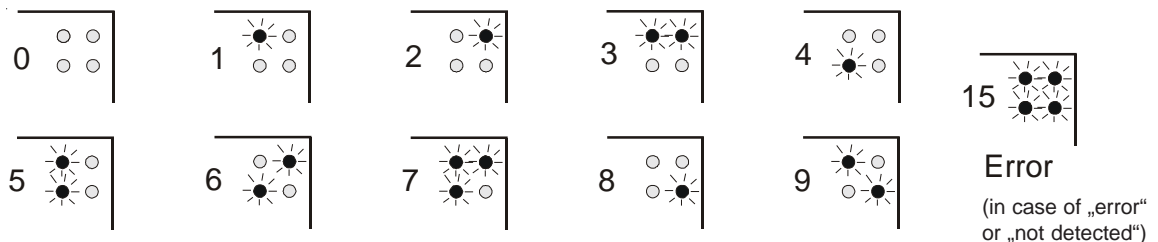
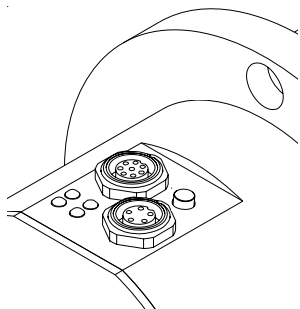

In the DIRECT mode the maximum numbers of colors to be taught is 4 (color no. 0,1,2,3). These 4 colors can be directly output at the 4 digital outputs. The respective detected color is displayed by means of the 4 yellow LEDs at the color sensor housing.



Parameterization

Windows® user interface:

The Windows® user interface facilitates the teach-in process at the color sensor and supports the operator in the task of adjustment and commissioning of the color sensor.

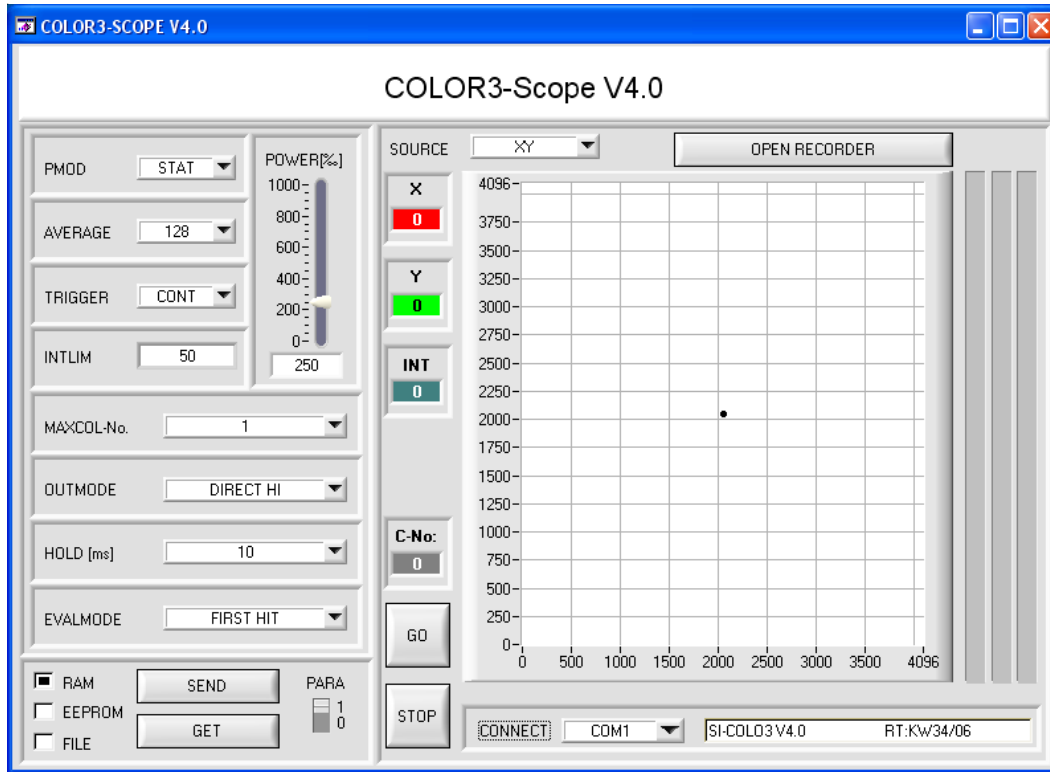

X,Y chart:

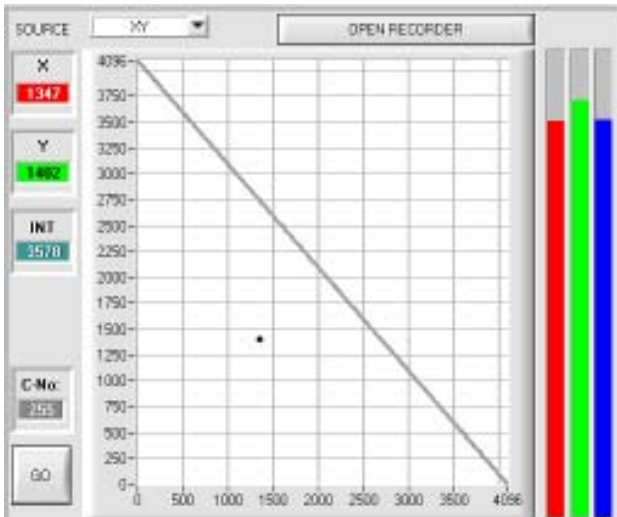

The color value is displayed graphically by way of the X,Y-color triangle and also in the numerical output fields. The current raw data (red, green, blue) from the color detector are visualized in a bar chart. If a color is detected during measuring operation, the currently detected color is displayed in a numeric output field:

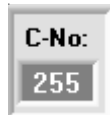

RGB-t chart:

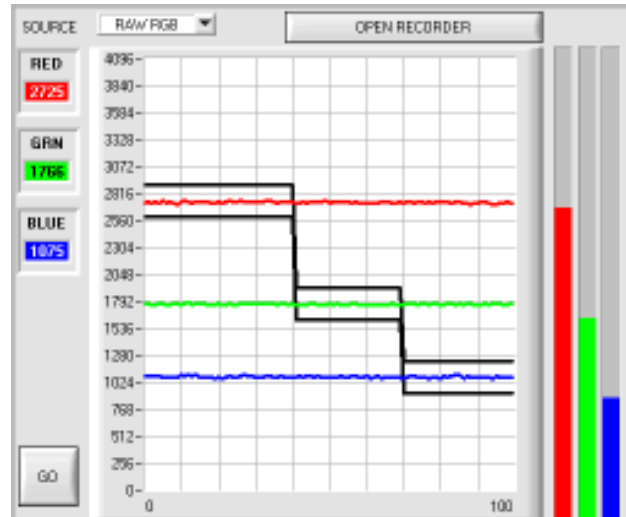

Display of the current raw data (red, green, blue) from the color sensor in „scroll mode“ (oscilloscope function). In addition the current raw data are visualized as a bar display. This facilitates the adjustment of the color sensor.



Parameterization

Parametereinstellung:

Es können u.a. folgende Parameter eingestellt werden:

POWER[%]
1000
800
600
400
200
0
250

POWER:

With this slider the intensity of the white-light transmitter LED at the sensor can be adjusted.

PMD STAT

PMD:

In this function field the operating mode of automatic light power control at the transmitter unit (white-light LED) can be set.

STAT: The LED transmission power is constantly kept at the value set with the POWER slider.

DYN: The LED transmission power is dynamically controlled in accordance with the amount of radiation that is diffusely reflected from the object.

AVERAGE 1024

AVERAGE:

Averaging (over 32768 scanning values max.). Here the number of scanning values over which the raw signal measured at the receiver is averaged can be set.

TRIGGER CONT
CONT
EXT1
EXT2

TRIGGER:

In this function field the trigger mode at the color sensor can be set.

CONT: Continuous color detection (no trigger event required).

EXT1 or EXT2: Color detection is activated through the external trigger input (IN0) or by pushing the TEACH button. A trigger event is detected as long as +24V is present at input IN0.

INTLIM 19

INTLIM:

This edit box is used for setting a lower intensity limit. Color evaluation is stopped if the total intensity of the three primary colors (red, green, blue) that is measured at the receiver unit falls below this limit.

MAXCOL-No. 15

MAXCOL-No.:

In this function field the number of colors to be checked can be set. With the color sensor a maximum of 15 colors can be checked.

OUTMODE BINARY

OUTMODE:

This group of buttons offers the method of how to control the 4 digital outputs.

HOLD [ms] 10

HOLD:

In this edit box a pulse lengthening (100 ms max.) at the digital outputs of the color sensor can be set.

Parameterization

EVALMODE FIRST HIT

- ✓ FIRST HIT
- MINIMAL DIST 1
- MINIMAL DIST 2
- EXTERN TEACH 1
- EXTERN TEACH 2
- CONTRAST RGB

EVALMODE:

In this function field the evaluation mode at the color sensor can be set:

FIRST HIT: The current color value (X,Y) lies within the tolerance circle of a taught color.

MINIMAL DIST1 or MINIMAL DIST2: The current color value (X,Y) is assigned to the teach-in color that lies next to this color value (X,Y) in the color triangle.

EXTERN TEACH1 or EXTERN TEACH2: Teaching procedure is started by setting the input to 0V for instance via PLC, or push button). The integrated yellow LED indicates the successful teaching procedure.

CONTRAST RGB: Intensity check of a selected primary color (red, green, blue) with a maximum switching frequency of 37,5 kHz.

No.	COLOR TEACH TABLE					COLOR
	X	Y	CTO	INT	ITO	
0	1489	1523	150	2432	150	Red
1	1466	2023	150	897	150	Green
2	2843	827	150	1079	150	Blue
3	1097	1574	150	1467	150	Black
4	1988	1841	150	1731	150	Pink
5	895	1066	150	767	150	Yellow
6	2203	1426	150	1181	150	Olive
7	1792	1960	150	1736	150	Purple
8	1531	1136	150	3030	150	Cyan
9	2310	734	150	1294	150	Magenta
10	1	1	1	1	1	Dark Purple
11	1	1	1	1	1	Pink
12	1	1	1	1	1	Green
13	1	1	1	1	1	Blue
14	1	1	1	1	1	Red

TEACH DATA TO No.: 4 Inc

APPLY FROM ALL ZOOM

AUTO ADJUST RESET TABLE

COLOR TEACH TABLE:

Input of parameters X, Y, CTO, INT, and ITO in the corresponding input fields, or automatically by clicking the **TEACH DATA TO** button.

- X: X-value of the teach-in color, normalized red color content
- Y: Y-value of the teach-in color, normalized green color content
- CTO: Tolerance circle around the teach color that is defined as (X,Y) point
- INT: Teach-in value for the total intensity
- ITO: Intensity tolerance around the INT teach-in value

APPLY FROM ALL Each of the color ranges defined in the color teach table is represented as a tolerance circle around the teach-in color (X,Y) after a click on the APPLY FROM ALL button. The tolerance circle around the teach-in color (X,Y) is specified by entering „CTO“.

AUTO ADJUST A click on this button initiates automatic adjustment of the circle tolerances (CTO). A circle tolerance of max. 200 DIGITS is allowed in calculation.

ZOOM A click on the ZOOM button opens a large graphic window with an automatic zoom function

RESET TABLE A click on this button resets the COLOR TEACH TABLE (RESET value = 1).

A click on **COLOR** opens a panel where the row color in which the individual tolerance circuits are represented can be individually chosen.

SET ROW COLOR

SELECT ROW: 0

SELECT COLOR: [Color Picker]

SET

SAVE ARRAY TO FILE

GET ARRAY FROM FILE

SET STARTUP ARRAY

"COLOR TRIANGLE":

In the color triangle the currently detected color is represented by an X,Y value pair, with the X-value representing the normalized red content, and the Y-value representing the normalized green content of the teach-in color. The blue content on the color triangle is proportional to the distance of the X,Y value pair from the hypotenuse.

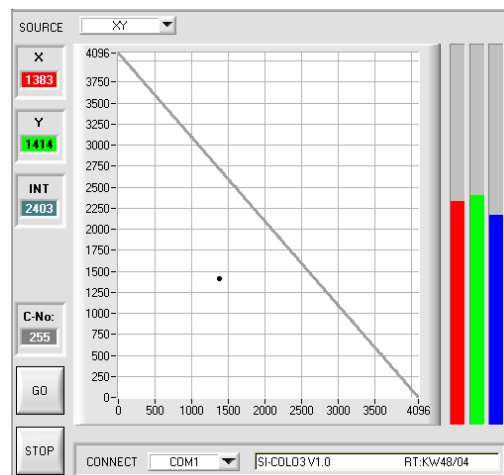

$$X = \frac{R}{R+G+B} * 4096$$

$$Y = \frac{G}{R+G+B} * 4096$$



Parameterization

Function of the RECORDER

The COLOR3-Scope software features a data recorder that makes it possible to save a certain number of RED/ GREEN/BLUE/X/Y/INT frames.

The recorded file is saved to the hard disk of your PC and can then be evaluated with a spreadsheet program.

The file that is created has seven columns and as many lines as data frames were recorded.

A line is structured as follows:

Date and Time, RED, GREEN, BLUE, X, Y, INT.

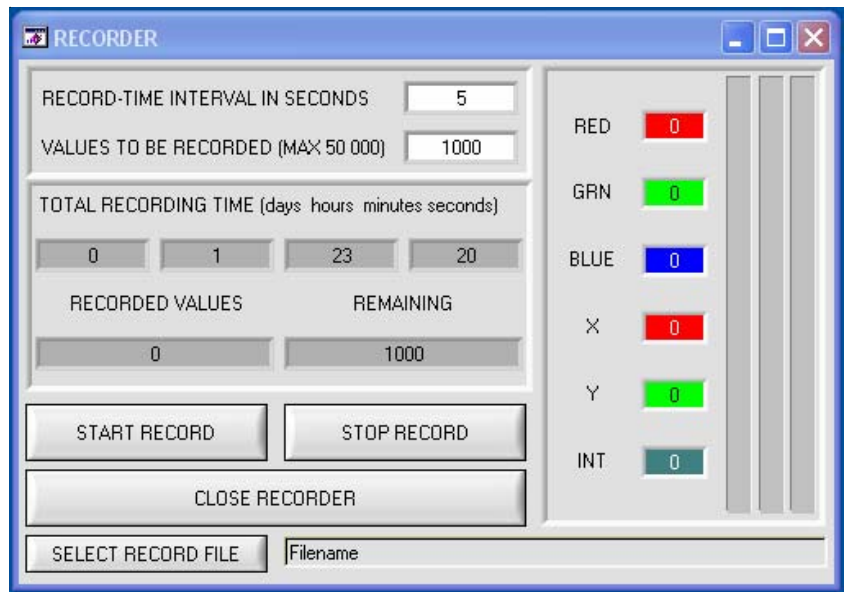

Calibration

Calibration of SI-COLO3 color sensors with software COLOR3-CALIB-Scope

The sensors of SI-COLO3 Series can be calibrated by means of separate software COLOR3-CALIB-Scope. The color balance can be done on any white target. In alternative, a ColorChecker™ is available which has 24 different color areas according to CIE norm. The calibration can be done on any of the white areas.

Calculation example for determination of the calibration factors:

In the example in the picture below, PMOD = STAT has been selected, i.e. a suitable POWER value at which the three bars of the raw signals are in the dynamic range has been set. Each of the three bars is at approx. 3000 digits. It is thus appropriate to set a setpoint value of 3000 (see SETVALUE) for the three bars. When calibration is now started by pressing CALCULATE CALIBRATION FACTORS, the software automatically calculates the calibration factors for channel RED, channel GREEN, and channel BLUE. The calibration factors are normalized as integers to the value 1024.

Formula:

$$CF_RED = (SETVALUE / RAW DATA RED) * 1024 = (3000 / 3081) * 1024 = 997$$

$$CF_GREEN = (SETVALUE / RAW DATA GREEN) * 1024 = (3000 / 3123) * 1024 = 984$$

$$CF_BLUE = (SETVALUE / RAW DATA BLUE) * 1024 = (3000 / 2944) * 1024 = 1043$$

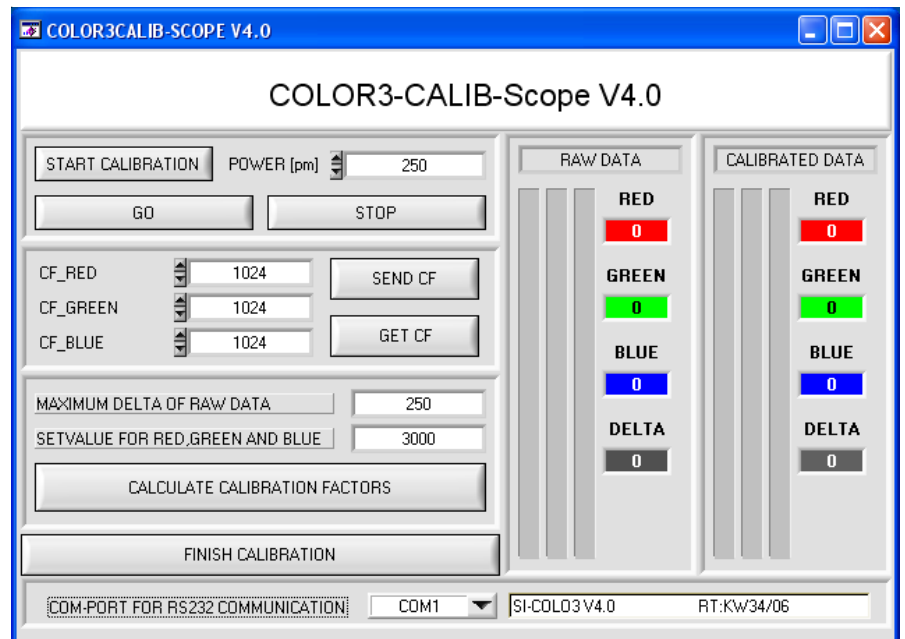

When the calibration factors have been calculated by the software on the user interface, they are automatically saved to the non-volatile EEPROM memory of the sensor. Calibration is then finished, and work with the COLOR3-Scope software can be continued.



Diagrams

Diagrams: SPOT SIZE (DIAMETER)

Spot size in diameter at reference distance 500 mm:

SI-COLO3-500-d2: Ø 23 mm (typ.)

SI-COLO3-500-d3: Ø 50 mm (typ.)

SI-COLO3-500-d2
SPOT DIAMETER [distance], typ.

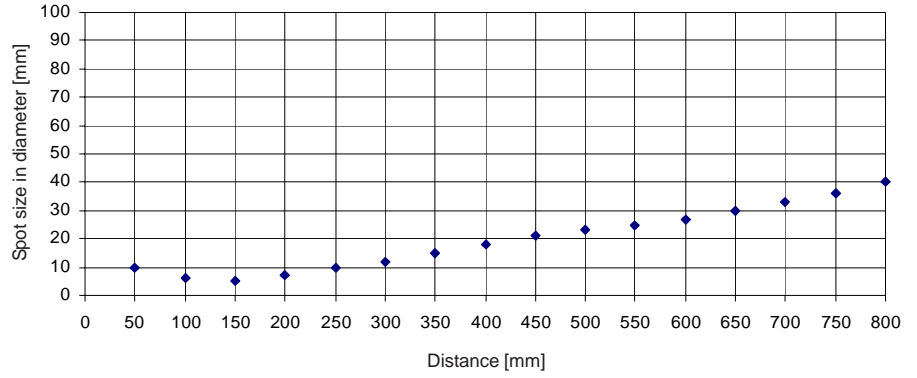

SI-COLO3-500-d3
SPOT DIAMETER [distance], typ.

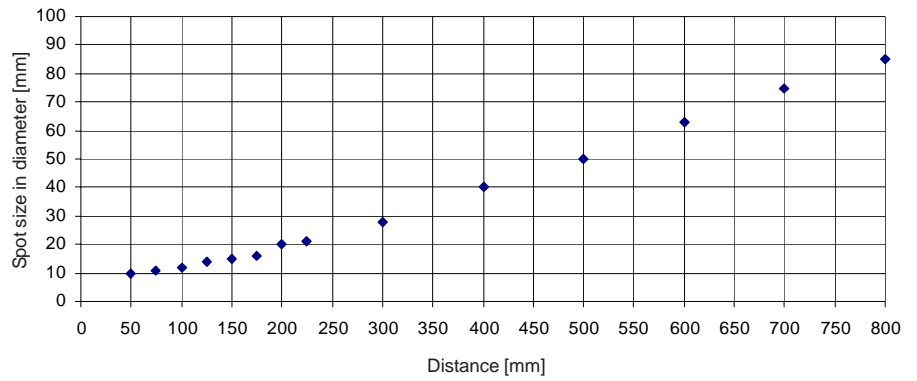



Notes