

SI-COLO Series

▶ SI-COLO4-80-FCL (12 bit A/D conversion)

- Measuring range typ. 40 mm ... 300 mm
- Up to 31 colors can be stored
- RS232 - interface (USB adapter available)
- 12x white-light LED, 30 kHz modulated, focused
- Color and gray scale detection, insensitive to outside light
- Brightness correction can be activated
- Several teach-functions (via PC, PLC, or push button)
- Various evaluation algorithms can be activated
- Switching state display by means of 5 yellow LEDs
- 'Averaging' can be activated (from 1 up to over 32000 values)
- Focused white-light area for dark/mat surfaces



Design

Product name:

SI-COLO4-80-FCL
SI-COLO4-80-FCL-TC (True Color)
 (incl. software COLOR4-Scope)

Accessories: (page 12)

SI-COLO-OFL-80 Top part for optics/spacer
 (makes it possible to use the
 SI-COLO4-80-FCL as a hand-held)

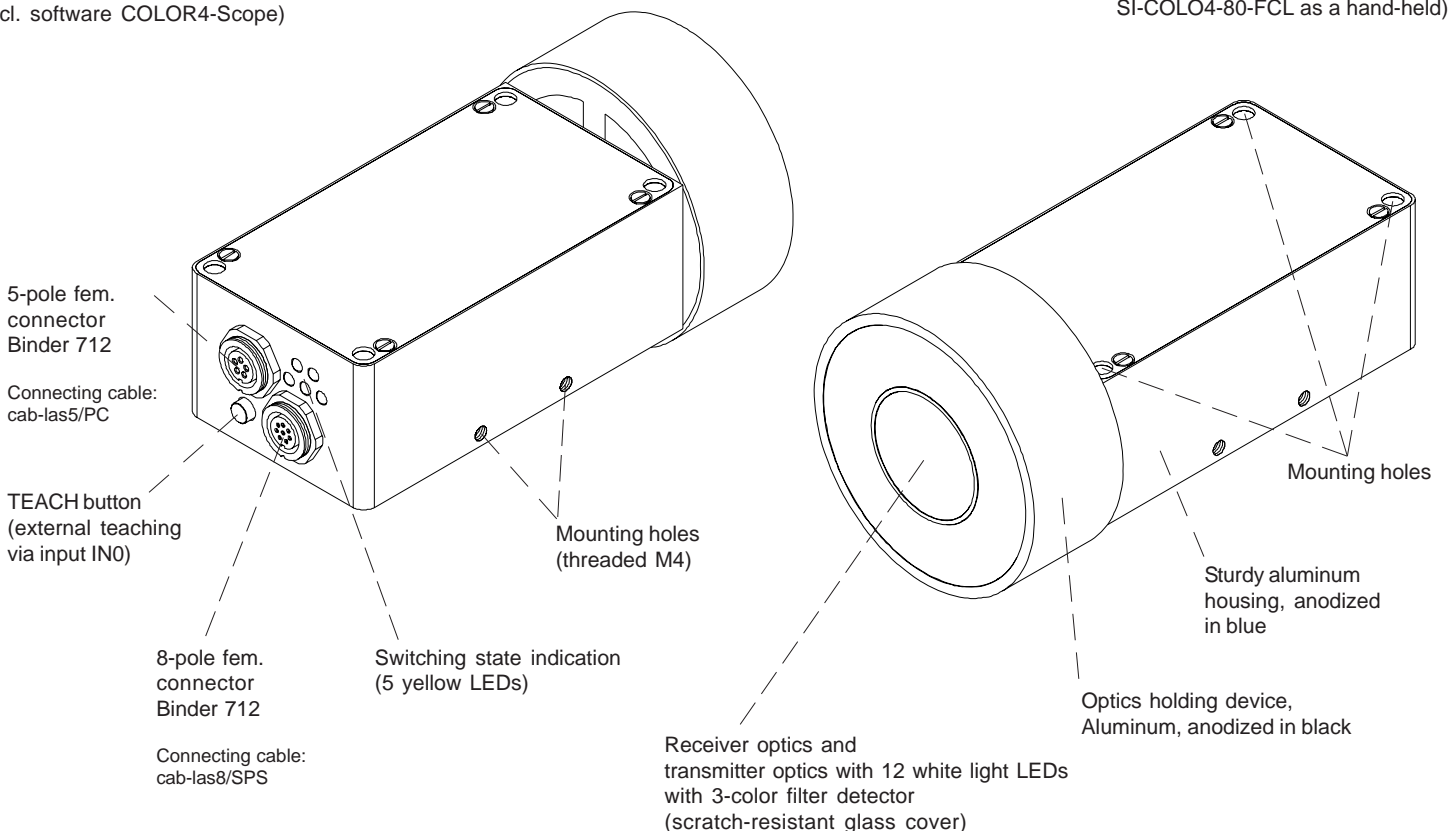

Parameterization under Windows® with software COLOR4-Scope:

The reflex color sensor SI-COLO4 can be parameterized via serial interface (RS232) under Windows®. Up to 31 colors can be taught, and stored in the sensor. If the sensor detects one of the taught colors, a change of switching state is performed through 5 encoded digital outputs (visual display by means of 5 yellow LEDs at the housing).



Technical Data

Model	SI-COLO4-80-FCL
Light source	12x white-light LED, modulated 30 kHz, focused
Target distance	typ. 40 mm ... 300 mm
Detection range (half intensity width)	typ. 25 mm (at 80 mm distance)
Reproducibility	In the X,Y color range 1 digit each at 12 bit A/D conversion
Receiver	3-color filter detector (in case of model "-TC": TRUE COLOR)
Alternating light operation	30 kHz
Ambient light	up to 5000 Lux
Type of protection	IP64
Current consumption	typ. 320 mA
Interface	RS232, parameterizable under Windows®
Connector type	Connection to PLC: 8-pole female connector (Binder Series 712) Connection to PC: 5-pole female connector (Binder Series 712)
EMC test acc. to	IEC - 801...
Housing material	Aluminum, anodized in blue Optics holding device made of aluminum, anodized in black
Operating temperature range	-20°C ... +55°C
Storage temperature range	-20°C ... +85°C
Pulse lengthening	adjustable under Windows® 0 ms ... 100 ms
Max. switching current	100 mA, short-circuit protected
Switching frequency	max. 30 kHz (depends on the number of teach-colors and averaging value)
Outputs	OUT 0 ... OUT 4, digital (0V/+Ub), short-circuit protected, 100 mA max. switching current nnp, pnp-output available (bright-, dark-switching can be switched over)
Averaging	over 32768 values max.
Voltage supply	+12VDC ... +30VDC, protected against polarity reversal, overload protected
Switching state display	Visualization by means of 5 yellow LEDs
Color memory capacity	Non-volatile EEPROM with parameter sets for 31 colors max.
TEACH button	for external teaching of color reference values via input IN0
Temperature drift X,Y	$\Delta X/\Delta T$; $\Delta Y/\Delta T$ typ. 0,3 digits/°C (< 0,01% / °C)

Dimensions

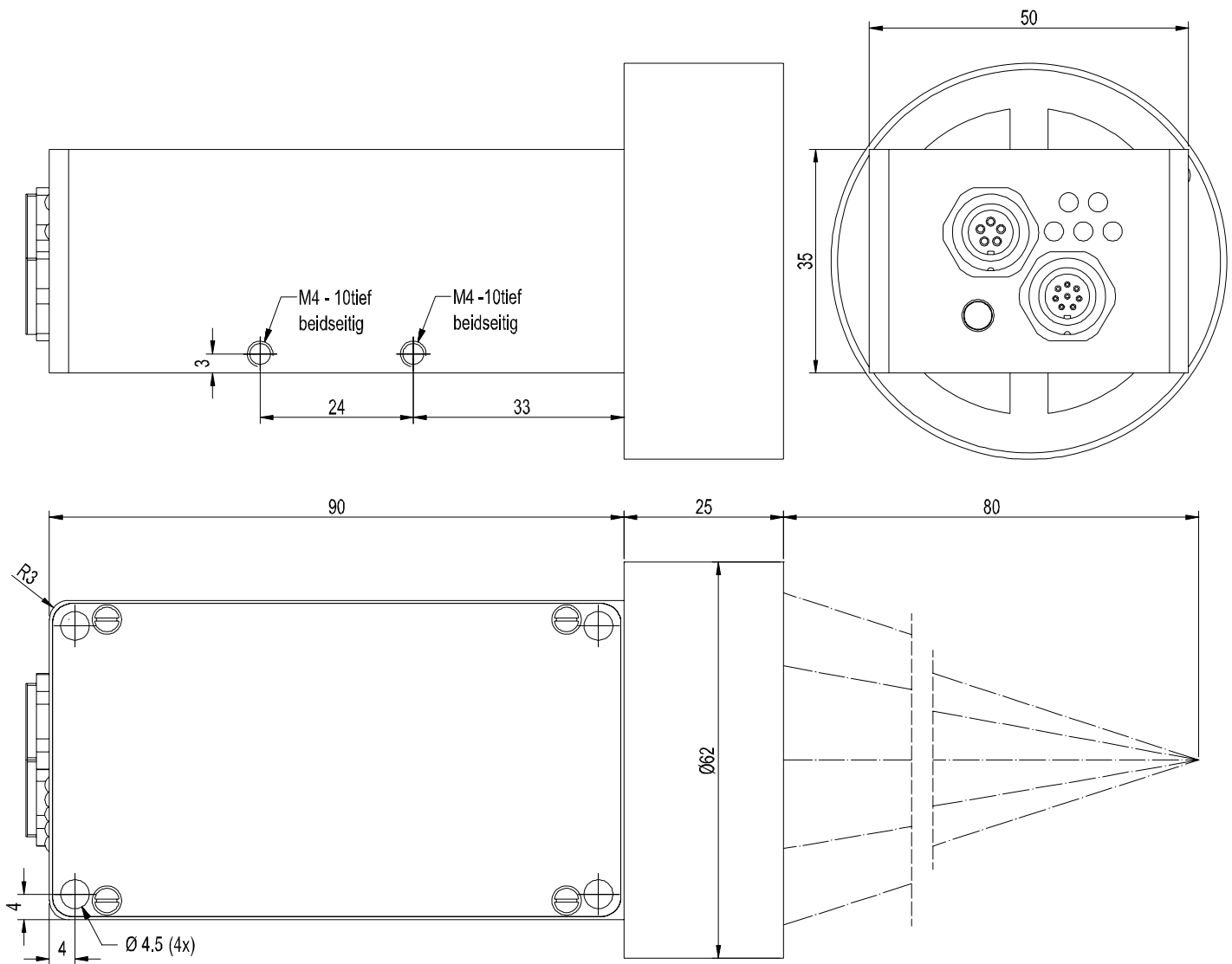

All dimensions in mm

Connector Assignment

Connection of SI-COLO4 to PLC:

8-pole female connector Binder 712

Pin:	Color:	Assignment:
1	wht	0V (GND)
2	brn	+12 ... +30 VDC
3	grn	IN0
4	yel	OUT0
5	gry	OUT1
6	pnk	OUT2
7	blu	OUT3
8	red	OUT4

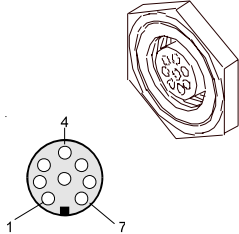

Connection of SI-COLO4 to PC:

5-pole female connector Binder 712

Pin:	Assignment:
1	0V (GND)
2	TX0
3	RX0
4	not connected
5	not connected

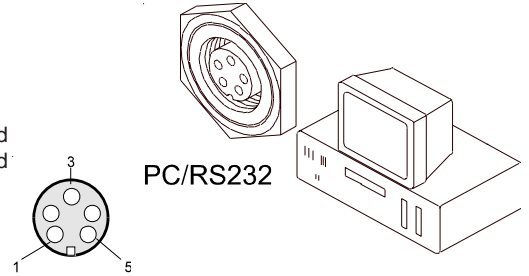

PC/RS232

Connecting Cables

Connecting cables for SI-COLO4:

cab-las8/SPS Length: 2m Outer jacket: PUR
cab-las5/PC Length: 2m Outer jacket: PUR

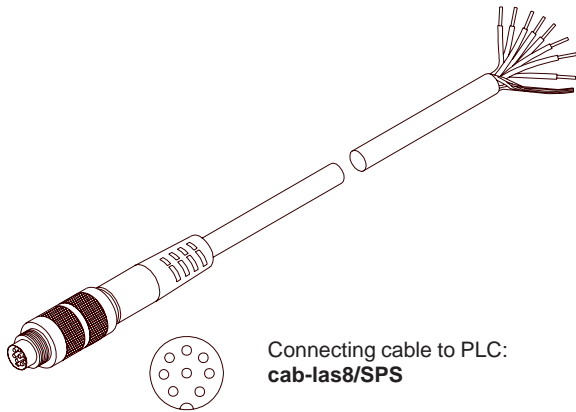

Connecting cable to PLC:
cab-las8/SPS

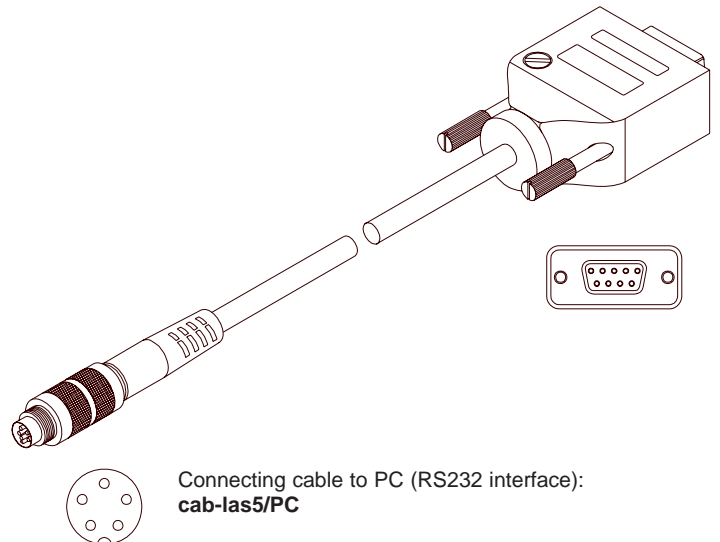

Connecting cable to PC (RS232 interface):
cab-las5/PC



Measuring Principle
Messprinzip:

Through an optical transmission unit a modulated white-light LED projects a white-light spot onto a surface to be checked. Through an optical receiver unit part of the light that is reflected from the target is then directed onto a color-sensitive detector element. The received light is separated according to the 3-color-range process (red, green, blue).



Windows® Software
Parameterisation under Windows® with software COLOR4-Scope:

The color sensor is parameterized under Windows® with the COLOR4-Scope software. The RS232 interface is used for setting parameters such as:

- Averaging over a maximum of 32768 values
- Number of colors to be checked
- Light power of the white-light LED
- Automatic light power control ON/OFF
- Pulse lengthening up to 100 ms max.
- External or continuous trigger
- Minimum intensity required for color evaluation

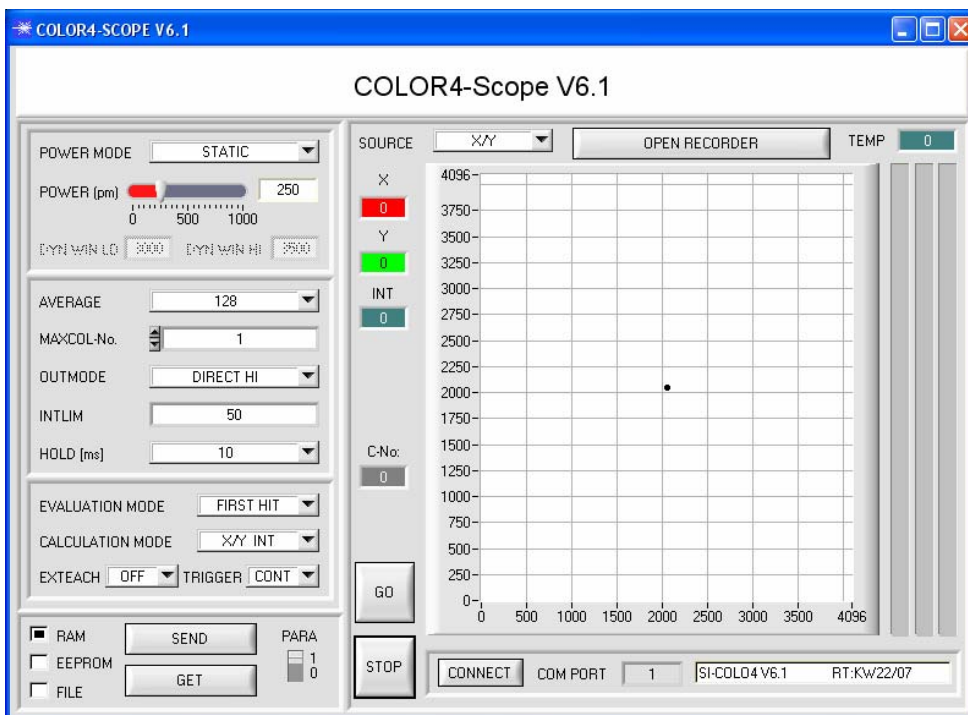

The Windows® user interface facilitates the teach-in process at the color sensor and supports the operator in the task of adjustment and commissioning of the color sensor.

Visualization:

Under Windows® representation of the color value on a PC in numeric form and in a color chart, and representation of RGB values in a time chart. In addition the current RGB values are displayed as a bar chart.



LED Display

LED display:

The color code is visualized by means of 5 yellow LEDs at the housing of the color sensor. At the same time the color code indicated at the LED display is output as 5-bit binary information at the digital outputs OUT0 ... OUT4 of the 8-pole PLC connector.

In the DIRECT mode the maximum number of color codes to be taught is 5. These 5 color codes can be directly output at the 5 digital outputs. The respective detected color code is displayed by means of the 5 yellow LEDs at the color sensor housing.

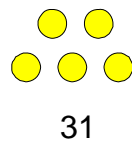
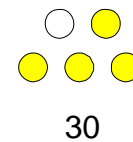
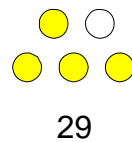
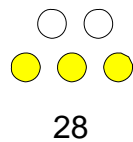
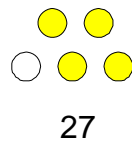
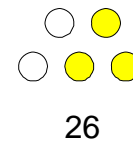
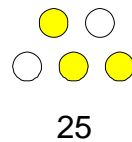
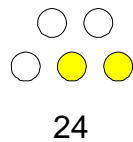
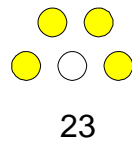
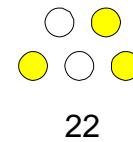
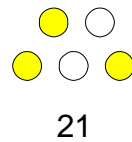
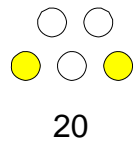
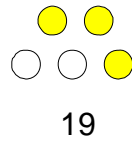
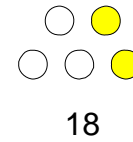
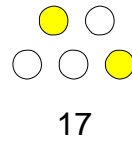
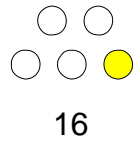
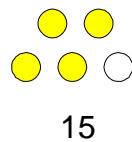
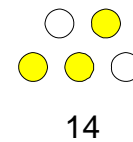
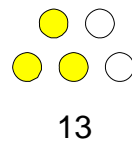
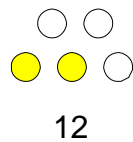
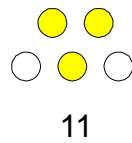
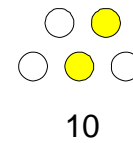
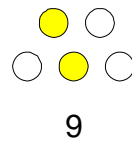
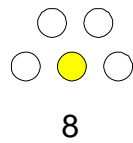
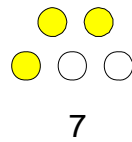
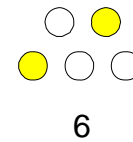
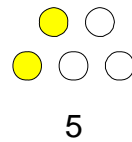
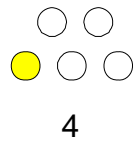
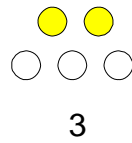
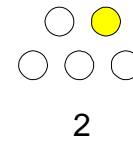
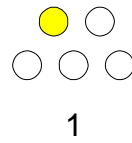
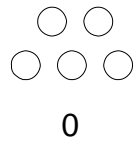
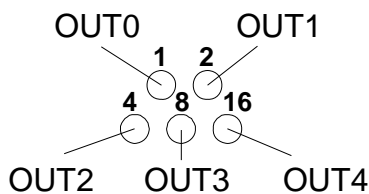
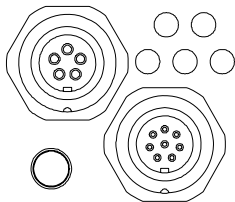

„Error“
or
„not detected“



Parameterisation

Windows® user interface:

The Windows® user interface facilitates the teach-in process at the color sensor and supports the operator in the task of adjustment and commissioning of the color sensor.

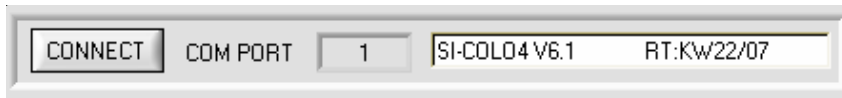

The COLOR4-Scope software starts with the standard configuration COM1 and the respective communication status.

CONNECT:
Pressing the CONNECT button opens a window for selecting and configuring the interface. The currently set connection type is displayed beside the CONNECT button.

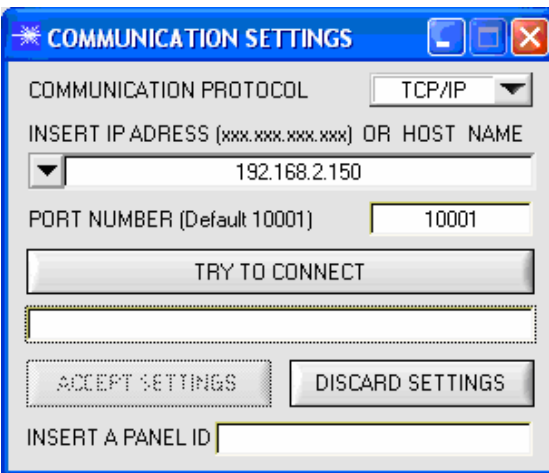
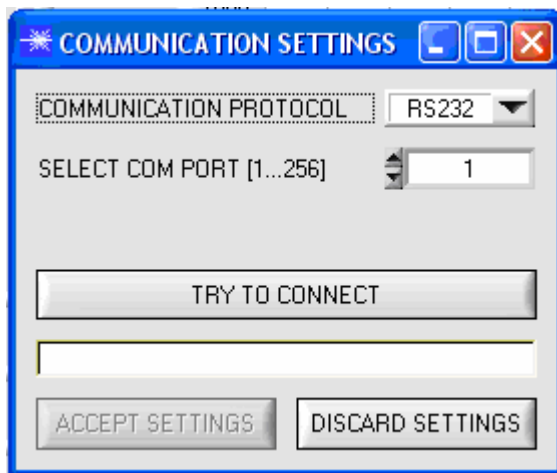

The COMMUNICATION PROTOCOL function field is used for selecting either an RS232 or a TCP/IP protocol. If RS232 is selected, a port from 1 to 256 can be selected with SELECT COM PORT, depending on which port the sensor is connected to.

If the sensor should communicate through a local area network, an RS232 to Ethernet adaptor will be needed. This adaptor makes it possible to establish a connection to the sensor with the TCP/IP protocol.

X,Y chart

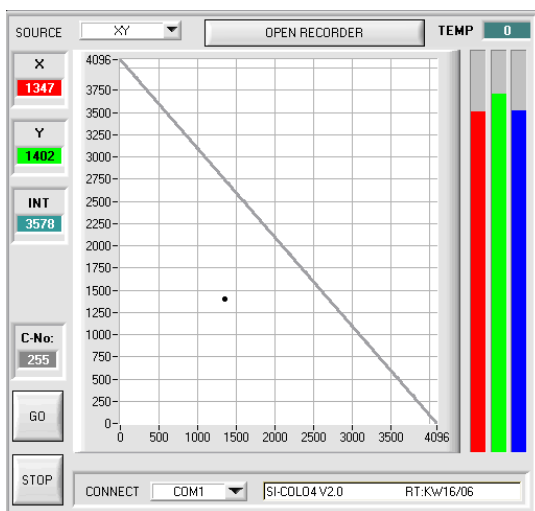

The color value is displayed graphically by way of the X,Y-color triangle and also in the numerical output fields. The current raw data (red, green, blue) from the color detector are visualized in a bar chart.

If a color is detected during measuring operation, the currently detected color is displayed in a numeric output field:

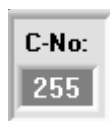

RGB-t chart

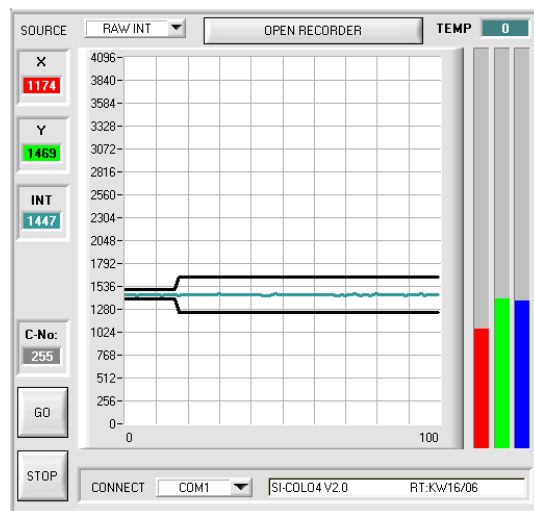

Display of the current raw data (red, green, blue) from the color sensor in „scroll mode“ (oscilloscope function). In addition the current raw data are visualized as a bar display. This facilitates the adjustment of the color sensor.



This display shows the temperature prevailing in the sensor housing.



Parameterisation
Parameter setting:

Among others, the following parameters can be set:

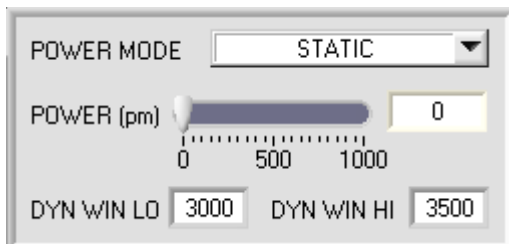
POWER MODE:

In this function field the operating mode of automatic power correction at the transmitter unit (transmitter LED) can be set.

STATIC:

The LED transmitter power is constantly kept at the value set with the POWER slider (recommended operation mode).

DYNAMIC:

The LED transmitter power is dynamically controlled in accordance with the amount of radiation that is diffusely reflected from the object. By using the intensities measured at the receivers the automatic control circuit attempts to adjust the transmitter power in such a way that the dynamic range, which is determined by DYN WIN LO and DYN WIN HI, is not exceeded.

POWER [pm]:

In this function field the intensity of the transmitter LED can be adjusted by using the slider or by entering a value in the edit box. A value of 1000 means full intensity at the transmitter LED, a value of 0 stands for the lowest transmitter intensity adjustment!

AVERAGE:

This function field is used for adjusting the number of scanning values (measurement values) over which the raw signal measured at the receiver is averaged. A higher AVERAGE default value reduces noise of the raw signals at the receiver unit and there will be a decrease of the maximal available switching frequency of the SI-COLO4 color sensor.

TRIGGER:

This function field serves for setting the trigger mode at the SI-COLO4 color sensor.

CONT: Continuous color detection (no trigger event required).

EXT1: Color detection is started through the external trigger input (IN0 pin3 green of cable cab-las8/SPS) or by means of a click on the TEACH button. A trigger event is recognized as long as +24V is present at the IN0 input (HIGH-active). After the trigger input goes to LOW again, the state (color no.) that was last detected will be held at the outputs.

EXT2: Same behaviour as in EXT1 mode, with the difference that an error state (color no. = 255) will be output after the trigger input goes to LOW again.

INTLIM:

This edit box is used for setting an intensity limit. Color evaluation is stopped, if the current intensity INT arriving at the receiver unit falls below this limit, and ERROR STATE is output.

EXTEACH:

In all the evaluation modes teaching of a color can be performed externally through IN0 or by means of the button at the sensor housing.

OFF: The external TEACH feature is deactivated.

ON : See below

STAT1: In static power mode, a color is taught to position 0 in the COLOR TEACH TABLE.

The POWER MODE is automatically set to STATIC. A fixed transmitter power must be set with the POWER slider. When the button at the sensor housing is pressed, or after a positive signal (+24V) at input IN0, the current color is taught to row 0.

DYN1: In dynamic power mode, a color is taught to position 0 in the COLOR TEACH TABLE, and evaluation is then performed statically. The POWER MODE is automatically set to STATIC.

When the button at the sensor housing is pressed, or after a positive signal (+24V) at input IN0, the transmitter power is set such that the sensor is in the dynamic range, which is defined by DYN WIN LO and DYN WIN HI. The current color is then taught to position 0 in the COLOR TEACH TABLE.

The sensor then continues to operate statically with the established POWER value.

TEACH PROCESS WITH EXTEACH=ON:

Through IN0 or by way of the button at the sensor housing, the sensor can be taught up to 31 colors.

Select the EXTERN TEACH = ON function.

Select how many colors you wish to teach externally.

Click on the „0“ field in the PARA switch to change to the COLOR TEACH TABLE.

Then enter the corresponding tolerances for the colors you want to teach.



Parameterisation

OUTMODE

OUTMODE:

This group of buttons offers the method of how to control the 5 digital outputs.

BINARY:

If in this row-by-row comparison the current color values correspond with the teach-in parameters entered in the COLOR TEACH TABLE, this color in the COLOR TEACH TABLE is displayed as a color number (C-No.) and is sent to the digital outputs (OUT0 ... OUT4) as a bit pattern. The maximum number of colors to be taught is 31.

DIRECT:

In this mode the maximum number of colors to be taught is 5.

If in this row-by-row comparison the current color values correspond with the teach-in parameters entered in the COLOR TEACH TABLE, this color in the color teach table is displayed as a color number (C-No.) and is sent direct to the digital outputs (OUT0 ... OUT4).

HOLD [ms]

HOLD:

In this edit box a pulse lengthening (100 ms max.) at the digital outputs of the color sensor can be set.

EVALUATION MODE

- FIRST HIT
- BEST HIT
- MIN DIST
- COL5

EVALUATION MODE:

In this function field the evaluation mode at the color sensor can be set:

FIRST HIT:

The currently measured color values are compared with the default values in the COLOR TEACH TABLE, starting with teach-color 0. If in the row-by-row comparison the current color values correspond with the teach-parameters entered in the COLOR TEACH TABLE, this first "hit" in the COLOR TEACH TABLE is displayed as a color number (C-No.) and is output at the digital outputs (OUT0 ... OUT4) according to the settings of the OUTMODE parameter (see OUTMODE). If the current color does not correspond with any of the teach-colors, the color code C-No. = 255 will be set ("error status").

BEST HIT:

The currently measured color values are compared with the default values in the COLOR TEACH TABLE, starting with teach-color 0. If in the row-by-row comparison the current color values correspond with several of the teach parameters entered in the color table, the teach parameter that has the shortest x/y distance from the current color value will be a hit.

This "hit" in the COLOR TEACH TABLE is displayed as a color number (C-No.) and is output at the digital outputs (OUT0 ... OUT4) according to the settings of the OUTMODE parameter (see OUTMODE). If the current color does not correspond with any of the teach-in colors, the color code C-No. = 255 will be set ("error status").

MIN DIST:

The individual teach-in colors defined in the COLOR TEACH TABLE are present as points in the color triangle, defined by their (X,Y) value pairs. When this evaluation mode is set at the SI-COLO4 color sensor, the evaluation algorithm, starting from the currently measured color value (X,Y), calculates the distance to the individual teach-in colors in the color triangle. The current color value (X,Y) is assigned to the teach-in color that is closest in the color triangle.

COL5:

In this evaluation mode the rows 0 to 4 in the COLOR TEACH TABLE are evaluated. Every match of current color (row number) and teach vector is directly sent to the corresponding output.

CALCULATION MODE

CALCULATION MODE:

X/Y INT: X/Y pairs of the individual contents of red, green, and blue, and the intensity are used for evaluation.

s/i M: "s.i." pairs of the individual contents of red, green, and blue, and M are calculated for evaluation. This calculation method follows the Lab calculation method.

No. CTT	COLOR GROUPS					ROWCOLOR
	X	Y	CTO	INT	ITO	
0	1	1	1	1	1	

COLOR GROUPS:

It is possible to form color groups in evaluation modes FIRST HIT, BEST HIT, and MIN DIST. This means that in a special table the individual rows are assigned to a group.

Parameterisation

No. CTT COLOR GROUPS ROWCOLOR

	X	Y	CTO	INT	ITO	
0	1489	1523	150	2432	150	Red
1	1466	2023	150	897	150	Green
2	2843	827	150	1079	150	Blue
3	1097	1574	150	1467	150	Black
4	1988	1841	150	1731	150	Pink
5	895	1066	150	767	150	Yellow
6	2203	1426	150	1181	150	Olive
7	1792	1960	150	1736	150	Purple
8	1531	1136	150	3030	150	Cyan
9	2310	734	150	1294	150	Magenta
10	1	1	1	1	1	Dark Purple
11	1	1	1	1	1	Pink
12	1	1	1	1	1	Green
13	1	1	1	1	1	Blue
14	1	1	1	1	1	Red

TEACH DATA TO No.: 4 Inc

APPLY FROM ALL ZOOM

AUTO ADJUST RESET TABLE

COLOR TEACH TABLE:

Input of parameters X, Y, CTO, INT, and ITO in the corresponding input fields, or automatically by clicking the **TEACH DATA TO** button.

- X or s: X-value of the teach-in color (in color triangle numerical value on x-axis: Red color content) s is calculated on the basis of the Lab color evaluation method
- Y or i: Y-value of the teach-in color (in color triangle numerical value on y-axis: Green color content) i is calculated on the basis of the Lab color evaluation method
- CTO or siTO: Color tolerance: "Tolerance circles" around the teach color in the color triangle that is defined as an (X,Y) or (s,i) point. The numerical value of CTO or siTO determines the radius of the "tolerance circle" around the teach color. Within the "tolerance circle" defined by this method, the current color is recognised as the teach color.
- INT or M: Teach-in value for the intensity of the respective color. M is calculated on the basis of the Lab color evaluation method
- ITO or MTO: Default value for the permitted tolerance band around the intensity or M teach-in value (intensity tolerance).

No.: Inc

No.: Selection of the current number of the teach-in color (0 ... 30) from the COLOR TEACH TABLE.
 Inc: When Inc is activated, and the TEACH DATA TO button is pressed, the No.: input field is automatically incremented (increased) by 1, i.e. the next row in the COLOR TEACH TABLE is selected.

APPLY FROM ALL

If X/Y is selected under SOURCE, a click on this button displays all the teach-in colors entered in the COLOR TEACH TABLE in the color triangle with the corresponding "tolerance circle" (radius=CTO or siTO).

AUTO ADJUST

A click on this button initiates automatic adjustment of the circle tolerances (CTO). A circle tolerance of max. 200 DIGITS is allowed in calculation.

ZOOM

A click on the ZOOM button opens a large graphic window with an automatic zoom function, i.e. the X/Y scale is dependent on the circle coordinates and the current cursor coordinates.

RESET TABLE

A click on this button resets the COLOR TEACH TABLE (RESET value = 1).

SET ROW COLOR

SET COLOR:

SELECT ROW:

SELECT COLOR:

SET

SAVE ARRAY TO FILE

GET ARRAY FROM FILE

SET STARTUP ARRAY

SET ROW COLOR

SET COLOR:

SELECT ROW:

SELECT COLOR:

SET

SAVE ARRAY TO FILE

GET ARRAY FROM FILE

SET STARTUP ARRAY



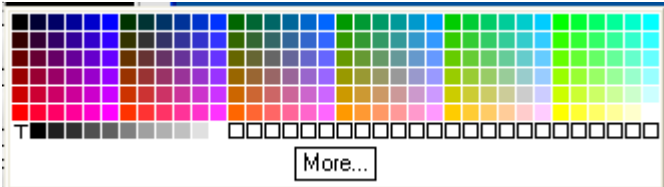

ROWCOLOR:

A click on ROW COLOR opens a panel where the row color in which the individual tolerance circuits are represented can be individually chosen or these can be automatically replaced by the color detected by the system. If SET COLOR is set to MANUAL, the row color that should be changed must be set under SELECT ROW. A click on the colored area of SELECT COLOR opens a color palette where the desired color can be selected. After a click on the SET button, the color will be displayed in the 6th column and the selected row of the COLOR TEACH TABLE. If SET COLOR is set to AUTO, the system will automatically calculate the corresponding row color, display the color in a color display beside the graph and, after a click on TEACH DATA TO, automatically insert it in the corresponding row. The SAVE ARRAY TO FILE and GET ARRAY FROM FILE functions allow you to save specified color-arrays on the hard disk, or to load previously saved color-arrays. SET STARTUP ARRAY is used for setting the selected path of an existing ARRAY. When the software is restarted, the corresponding ARRAY is automatically loaded and displayed in the COLOR TEACH TABLE.



Parameterisation

Function of the data recorder (RECORDER)

The COLOR4-Scope software features a data recorder that makes it possible to save a certain number of RED/GREEN/BLUE/X/Y/INT frames. The recorded file is saved to the hard disk of your PC and can then be evaluated with a spreadsheet program.

The file that is created has six columns and as many lines as data frames were recorded.

A line is structured as follows:

Date and time, RED, GREEN, BLUE, X, Y, INT.

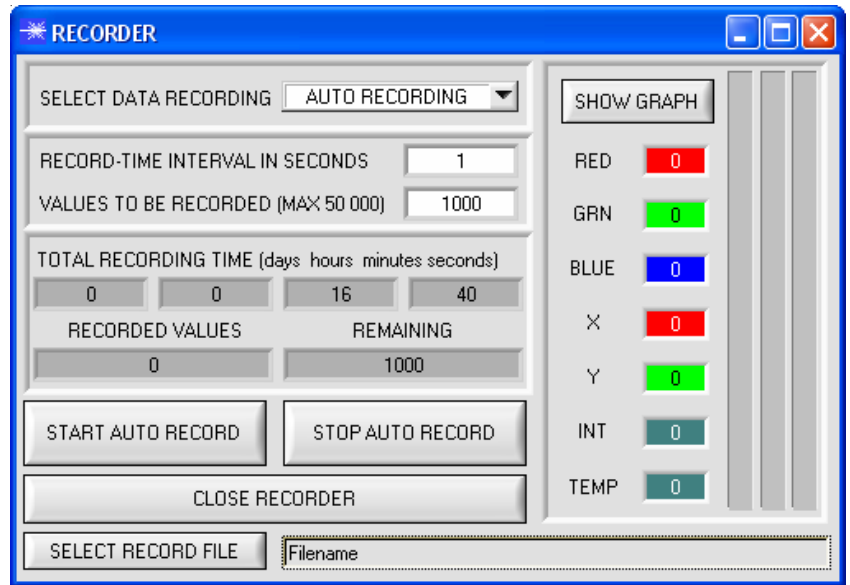

Calibration

Calibration of SI-COLO4 color sensors with software COLOR4-CALIB-Scope

The sensors of SI-COLO4 Series can be calibrated by means of separate software COLOR4-CALIB-Scope. The color balance can be done on any white target. In alternative, a ColorChecker™ is available which has 24 different color areas according to CIE norm. The calibration can be done on any of the white areas (cf. separate manual for COLOR4-CALIB-Scope).

Calculation example for determining the calibration factors:

In the example in the picture below, a POWER value at which the three bars of the raw signals are in the dynamic range has been set. Each of the three bars is at approx. 3600 digits. It is thus appropriate to set a setpoint value of 3600 (see SETVALUE) for the three bars. When calibration is now started by pressing CALCULATE CALIBRATION FACTORS, the software automatically calculates the calibration factors for channel RED, channel GREEN, and channel BLUE. The calibration factors are normalized as integers to the value 1024.

Formula:

$$CF_RED = (SETVALUE / RAW DATA RED) * 1024 = (3600 / 3512) * 1024 = 1049$$

$$CF_GREEN = (SETVALUE / RAW DATA GREEN) * 1024 = (3600 / 3694) * 1024 = 997$$

$$CF_BLUE = (SETVALUE / RAW DATA BLUE) * 1024 = (3600 / 3625) * 1024 = 1015$$

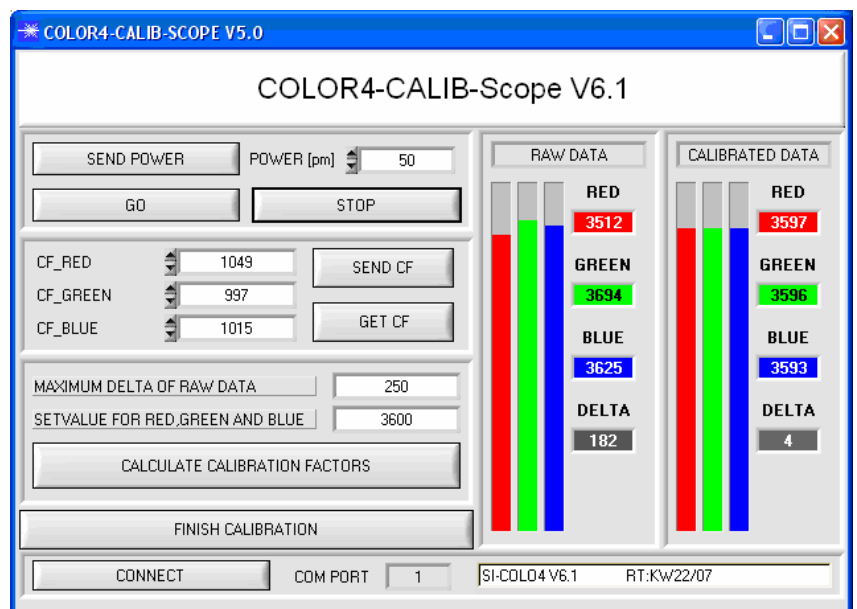

When the calibration factors have been calculated by the software on the user interface, they are automatically saved to the non-volatile EEPROM memory of the sensor. Calibration is then finished, and work with the COLOR4-Scope software can be continued



Accessories

SI-COLO-OFL-80

Top part for optics / spacer
(please order separately)

Mounted on the SI-COLO4-80-FCL, the spacer makes it possible to use the color sensor as a hand-held.

For color measurement, the SI-COLO4-80-FCL with the spacer is put directly on the surface of the object to be measured.

With the help of the spacer, the color sensor SI-COLO4-80-FCL works at a reference distance from 80 mm to the object respectively surface to be measured by direct contact.

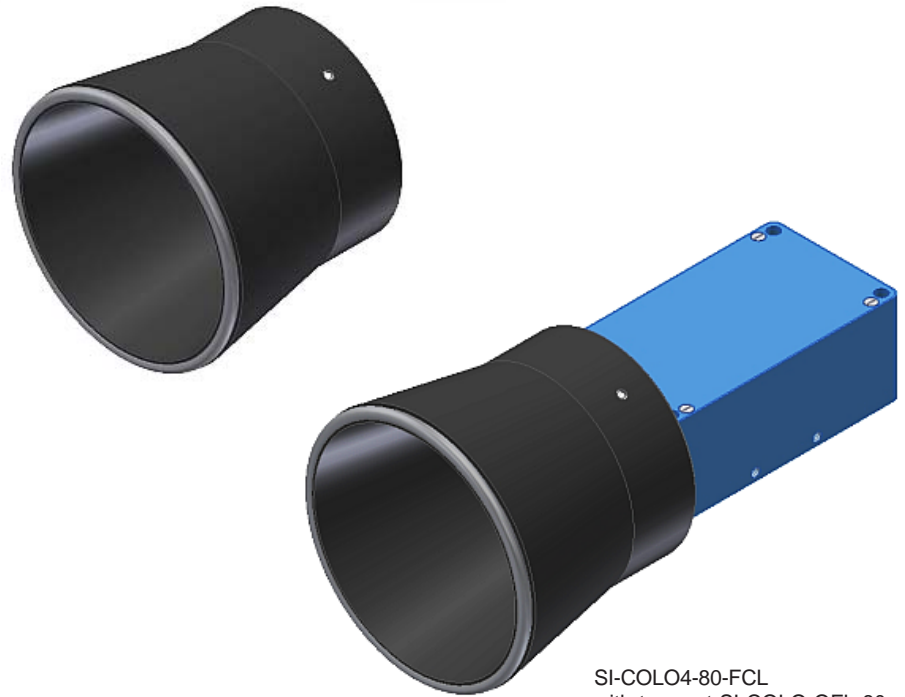

SI-COLO4-80-FCL
with top part SI-COLO-OFL-80

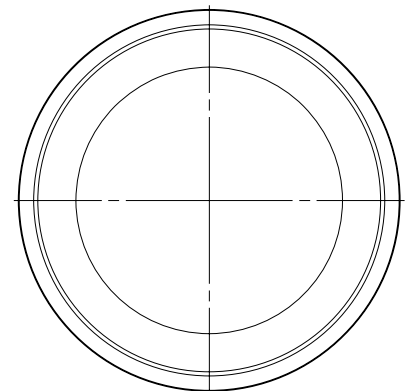
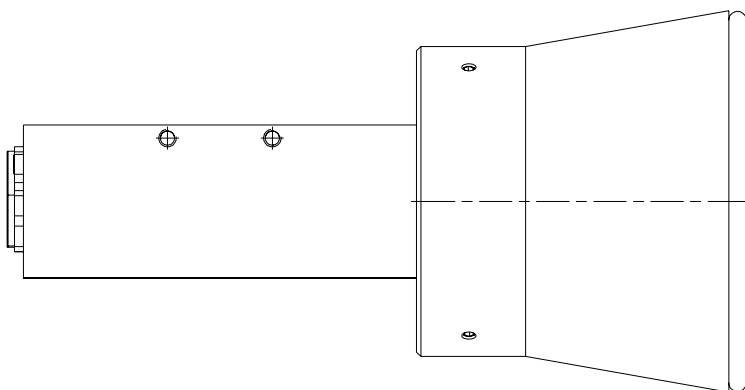
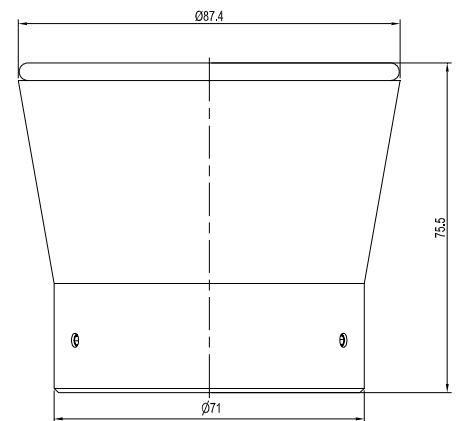
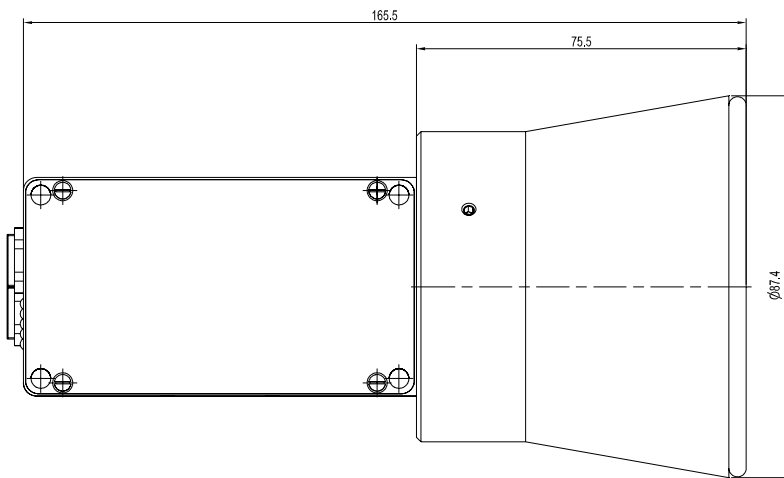

All dimensions in mm