

SI-COLO Series

► SI-COLO2-80

- Measuring range typ. 50 mm ... 150 mm
- Up to 15 colors can be stored
- RS232 - interface (USB adapter available)
- White-light LED, 100 kHz modulated
- Color and gray scale detection
- Brightness correction can be activated
- Several teach-functions (via PC, PLC, or push button)
- Various evaluation algorithms can be activated
- Switching state display by means of 4 yellow LEDs
- Insensitive to outside light
- 'Material adaptation' can be activated (adaptive control)
- 'Averaging' can be activated (from 1 up to over 32000 values)



Design

Product name:

SI-COLO2-80-d1

SI-COLO2-80-d2

SI-COLO2-80-d3

(incl. Software COLOR2-Scope)

d1 = Light spot diameter Ø 6.5 mm (typ.) at 80 mm distance

d2 = Light spot diameter Ø 9.0 mm (typ.) at 80 mm distance

d3 = Light spot diameter Ø 13.0 mm (typ.) at 80 mm distance

Accessories:

COL-BL-80

(blast air attachment, cf. page 14)

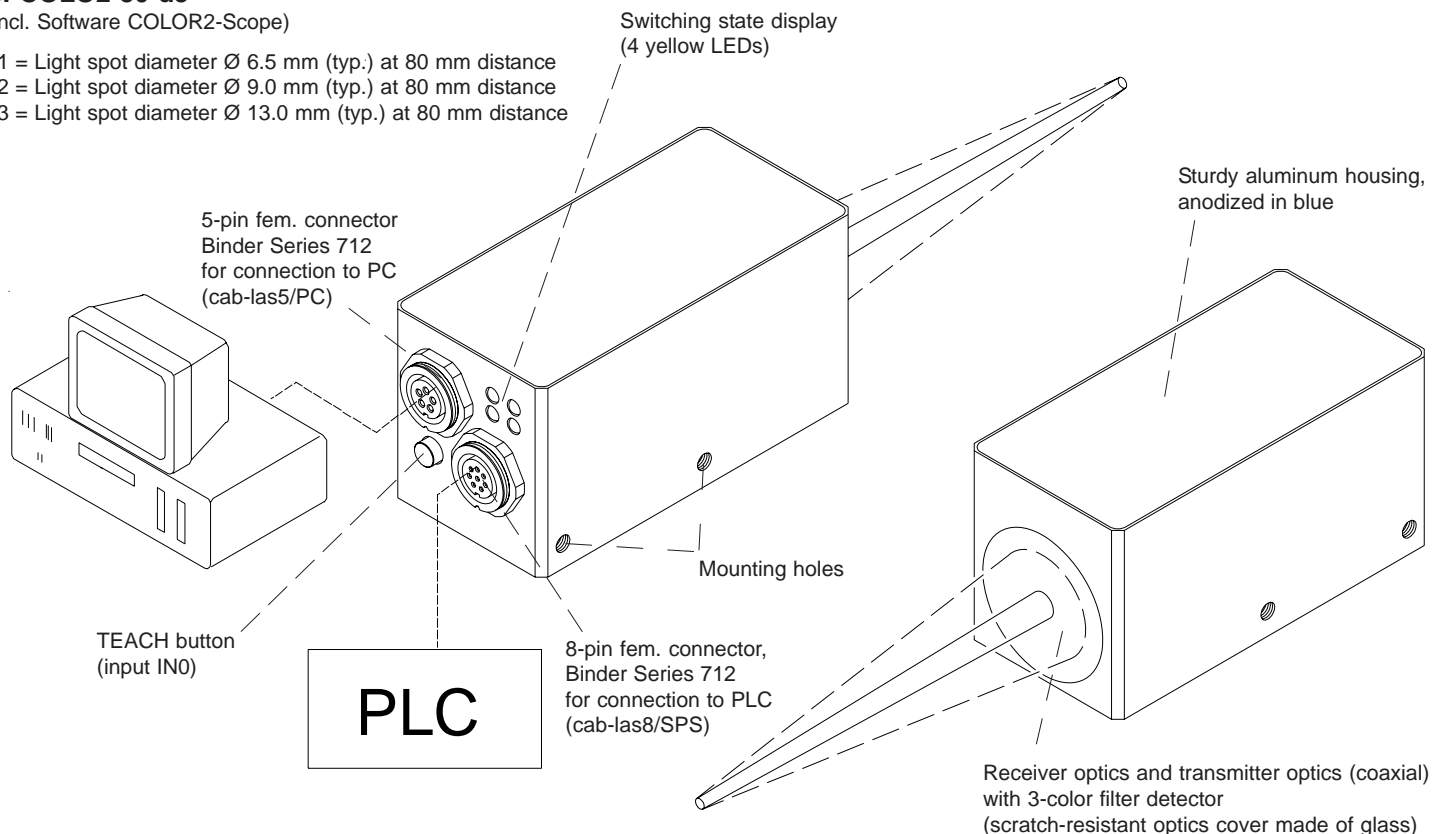

Parameterization under Windows® with software COLOR2-Scope:

The reflex color sensor SI-COLO2-80 can be parameterized via serial interface (RS232) under Windows® (please cf. pages 5-7). Up to 15 colors can be taught, and stored in the sensor. If the sensor detects one of the taught colors, a change of switching state is performed through 4 encoded digital outputs (visual display by means of 4 yellow LEDs at the housing).



Technical Data

Model	SI-COLO2-80-...
Light source	White-light LED, modulated 100 kHz
Target distance	typ. 50 mm ... 150 mm
Light spot size	Type d1: typ. 6.5 mm in diameter at 80 mm distance Type d2: typ. 9.0 mm in diameter at 80 mm distance Type d3: typ. 13.0 mm in diameter at 80 mm distance
Reproducibility	In the X,Y color range 1 digit each at 8 bit A/D conversion
Receiver	3-color filter detector
Pulsating light operation	100 kHz
Ambient light	Up to 5000 Lux
Type of protection	IP64
Current consumption	typ. 180 mA
Interface	RS232, parameterizable under Windows®
Connector type	Connection to PLC: 8-pin female connector (Binder Series 712) Connection to PC: 5-pin female connector (Binder Series 712)
EMC test acc. to	IEC - 801...
Housing material	Aluminum, anodized in blue
Operating temperature range	-20°C ... +55°C
Storage temperature range	-20°C ... +85°C
Pulse lengthening	Adjustable under Windows® 0 ms ... 100 ms
Max. switching current	100 mA, short-circuit-proof
Switching frequency	Max. 10 kHz (depends on number of colors to be taught and on average setting)
Outputs	OUT 0 ... OUT 3
Averaging	Over 32768 values max.
Voltage supply	+12VDC ... +30VDC, protected against polarity reversal, overload-protected
Switching state display	Visualization by means of 4 yellow LEDs
Color memory capacity	Non-volatile EEPROM with parameter sets for 15 colors max.
Teach button	for external teaching of color reference values via input IN0



Technical Data

DYN-Mode Object 10° inclined to the horizontal		COLOR VALUE CHANGE [distance], typ.	
SI-COLO2-80-d1: Object distance 50 mm ... 125 mm	$\Delta x = \pm 7$ $\Delta x = \pm 6$ $\Delta x = \pm 9$ $\Delta x = \pm 6$	$\Delta y = \pm 8$ $\Delta y = \pm 5$ $\Delta y = \pm 8$ $\Delta y = \pm 7$	Color: RAL 3020 (traffic red) Color: RAL 1026 (luminous yellow) Color: RAL 6024 (traffic green) Color: RAL 5017 (traffic blue)
SI-COLO2-80-d2: Object distance 50 mm ... 125 mm	$\Delta x = \pm 7$ $\Delta x = \pm 4$ $\Delta x = \pm 3$ $\Delta x = \pm 3$	$\Delta y = \pm 6$ $\Delta y = \pm 3$ $\Delta y = \pm 5$ $\Delta y = \pm 5$	Color: RAL 3020 (traffic red) Color: RAL 1026 (luminous yellow) Color: RAL 6024 (traffic green) Color: RAL 5017 (traffic blue)
SI-COLO2-80-d3: Object distance 50 mm ... 150 mm	$\Delta x = \pm 4$ $\Delta x = \pm 2$ $\Delta x = \pm 5$ $\Delta x = \pm 3$	$\Delta y = \pm 3$ $\Delta y = \pm 2$ $\Delta y = \pm 5$ $\Delta y = \pm 3$	Color: RAL 3020 (traffic red) Color: RAL 1026 (luminous yellow) Color: RAL 6024 (traffic green) Color: RAL 5017 (traffic blue)
STAT-Mode Object 10° inclined to the horizontal		COLOR VALUE CHANGE [distance], typ.	
SI-COLO2-80-d1: Object distance 50 mm ... 90 mm	$\Delta x = \pm 6$	$\Delta y = \pm 7$	Color: RAL 3020 (traffic red)
SI-COLO2-80-d2: Object distance 50 mm ... 90 mm	$\Delta x = \pm 10$	$\Delta y = \pm 7$	Color: RAL 3020 (traffic red)
SI-COLO2-80-d3: Object distance 50 mm ... 100 mm	$\Delta x = \pm 4$	$\Delta y = \pm 2$	Color: RAL 3020 (traffic red)
DYN-Mode Object 10° inclined to the horizontal		COLOR VALUE CHANGE [temperature], typ.	
SI-COLO2-80-... : Object distance 80 mm	$\Delta x/\Delta T = 0.3/^\circ\text{C}$ $\Delta y/\Delta T = 0.2/^\circ\text{C}$		Color: RAL 3020 (traffic red)
DYN-Mode Object 10° inclined to the horizontal		INTENSITY CHANGE [temperature], typ.	
SI-COLO2-80-... : Object distance 80 mm	$\Delta \text{INT}/\Delta T = 0.1/^\circ\text{C}$		Color: RAL 3020 (traffic red)
STAT-Mode Object 10° inclined to the horizontal		COLOR VALUE CHANGE [temperature], typ.	
SI-COLO2-80-... : Object distance 80 mm	$\Delta x/\Delta T = 0.3/^\circ\text{C}$ $\Delta y/\Delta T = 0.2/^\circ\text{C}$		Color: RAL 3020 (traffic red)
STAT-Mode Object 10° inclined to the horizontal		INTENSITY CHANGE [temperature], typ.	
SI-COLO2-80-... : Object distance 80 mm	$\Delta \text{INT}/\Delta T = 0.7/^\circ\text{C}$		Color: RAL 3020 (traffic red)

Dimensions

All dimensions in mm

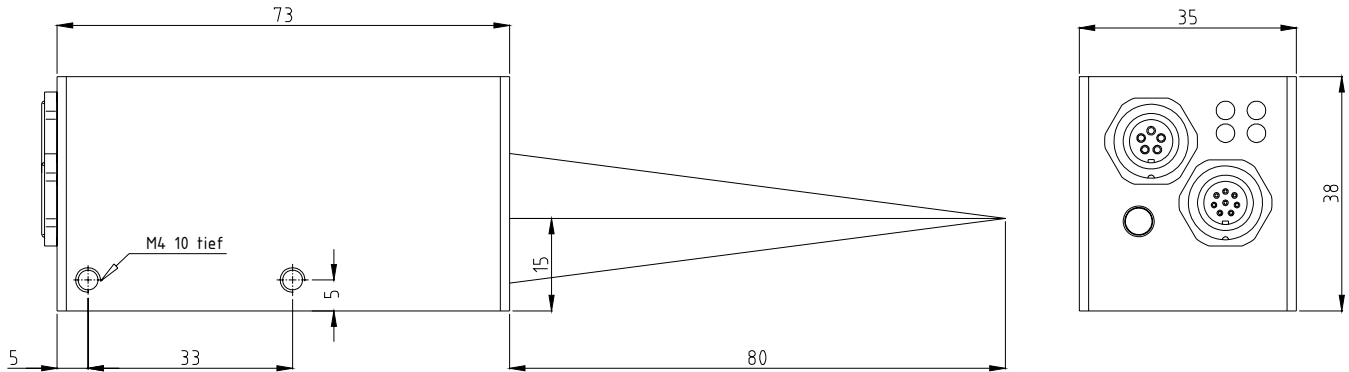

Connector Assignment

Connection of SI-COLO2-80 to PLC:

8-pin female connector Binder Series 712

Pin:	Color:	Assignment:
1	wht	GND (0V)
2	brn	+12 ... +30VDC
3	grn	IN0
4	yel	OUT0
5	gry	OUT1
6	pnk	OUT2
7	blu	OUT3
8	red	n.c.

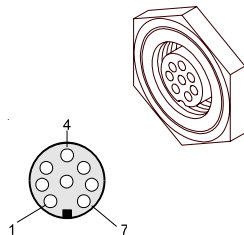

Connection of SI-COLO2-80 to PC:

5-pin female connector Binder Series 712

Pin:	Assignment:
1	GND (0V)
2	TX0
3	RX0
4	n.c.
5	n.c.

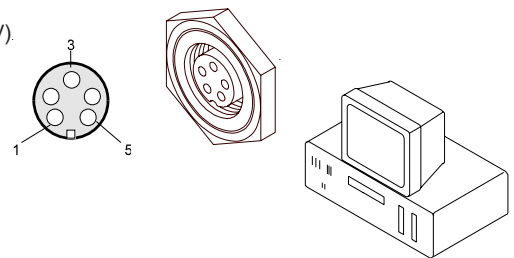

Connecting Cables

Connecting cables for SI-COLO2-80:

cab-las8/SPS	Length: 2m	Outer jacket: PUR
cab-las5/PC	Length: 2m	Outer jacket: PUR

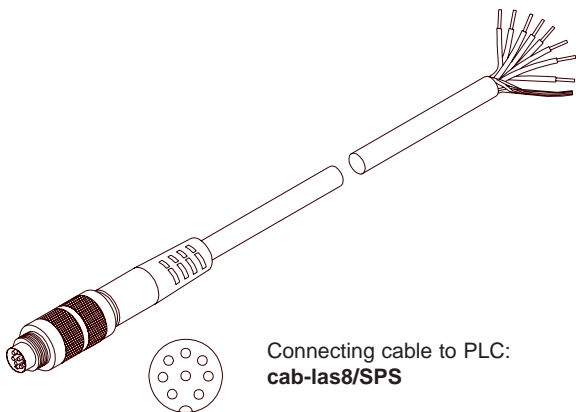

Connecting cable to PLC:
cab-las8/SPS

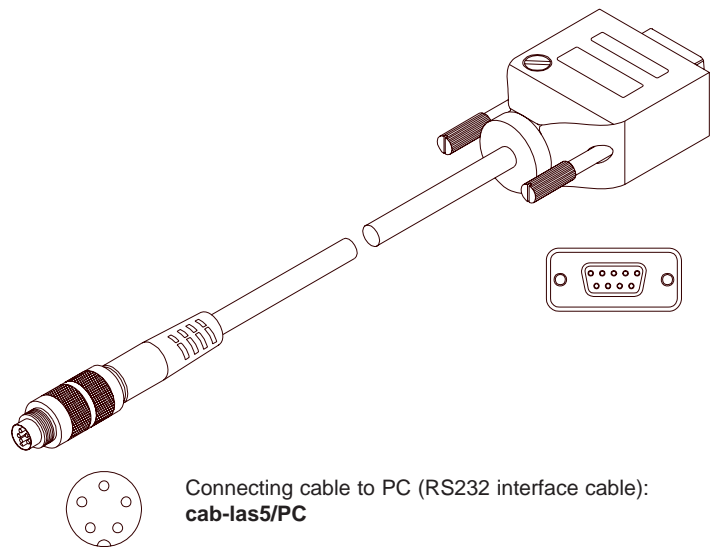

Connecting cable to PC (RS232 interface cable):
cab-las5/PC



Measuring Principle
Measuring principle:

Through an optical transmission unit a modulated white-light LED projects a white-light spot onto a surface to be checked. Through an optical receiver unit part of the light that is reflected from the target is then directed onto a color-sensitive detector element. The received light is separated according to the 3-color-range process (red, green, blue).



Parameterization
Parameterization under Windows® with software COLOR2-Scope:

The color sensor is parameterized under Windows® with the COLOR2-Scope software. The RS232 interface is used for setting parameters such as:

- Averaging over a maximum of 32768 values
- Number of colors to be checked
- Light power of the white-light LED
- Automatic light power control ON/OFF
- Pulse lengthening up to 100ms max.
- External or continuous trigger
- Minimum intensity required for color evaluation

Visualization:

Under Windows® representation of the color value on a PC in numeric form and in a color chart, and representation of RGB values in a time chart. In addition the current RGB values are displayed as a bar chart.

The following evaluation algorithms can also be selected:

- Target lies within the color tolerance circle of a taught color and within an intensity window (FIRST HIT)
- Determination of the taught color that is most similar to the target (minimum distance between target color and reference color in the color chart) (MINIMAL DIST)
- Checking of the target's color series with a taught color sequence (COLOR SERIES)
- Contrast check of the target. In this case only one primary color (freely selectable) is used for evaluation (CONTRAST)
Advantage: Possibility of using a very high scanning rate of up to 28 kHz.
- EXTERN TEACH: With this function field the color sensor can be taught by means of a LOW-signal at pin 3 (for instance via push button, or PLC). During this procedure the object to be taught has to be in the visibility range of the color sensor. The yellow LEDs indicate a successful teaching procedure.
- ADAPTIVE CONTROL: During measurement the sensor permanently teaches itself the current setpoint value, i.e. it adapts itself to possible product fluctuations.

LED-Display:

The color code is visualized by means of 4 yellow LEDs at the housing of the color sensor. At the same time the color code indicated at the LED display is output as 4-bit binary information at the digital outputs OUT0 to OUT3 of the 8-pin SI-COLO2/PLC connector.

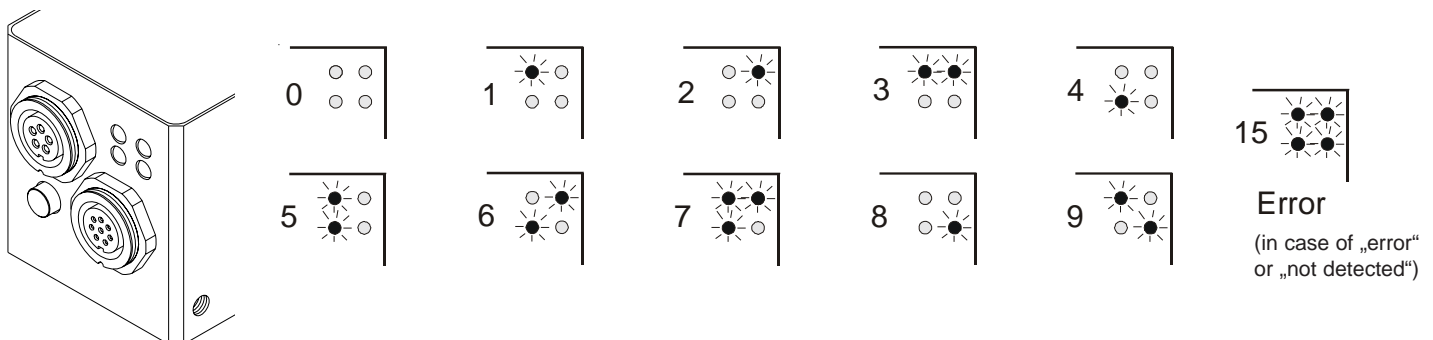

In the DIRECT mode the maximum numbers of colors to be taught is 4 (color no. 0,1,2,3). These 4 colors can be directly output at the 4 digital outputs. The respective detected color is displayed by means of the 4 yellow LEDs at the color sensor housing.



Parameterization

Windows® user interface:

The Windows® user interface facilitates the teach-in process at the color sensor and supports the operator in the task of adjustment and commissioning of the color sensor.

X,Y-chart:

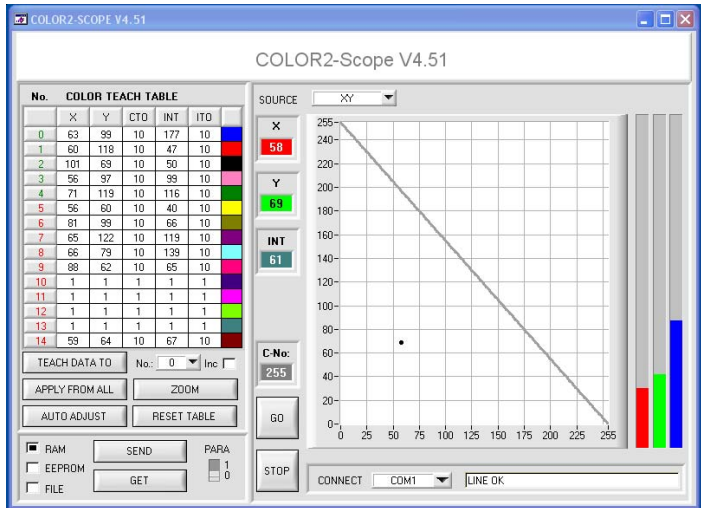

The color value is displayed graphically by way of the X,Y-color triangle and also in the numerical output fields. The current raw data (red, green, blue) from the color detector are visualized in a bar chart. If a color is detected during measuring operation, the currently detected color is displayed in a numeric output field:

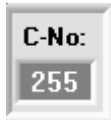

RGB-t-chart:

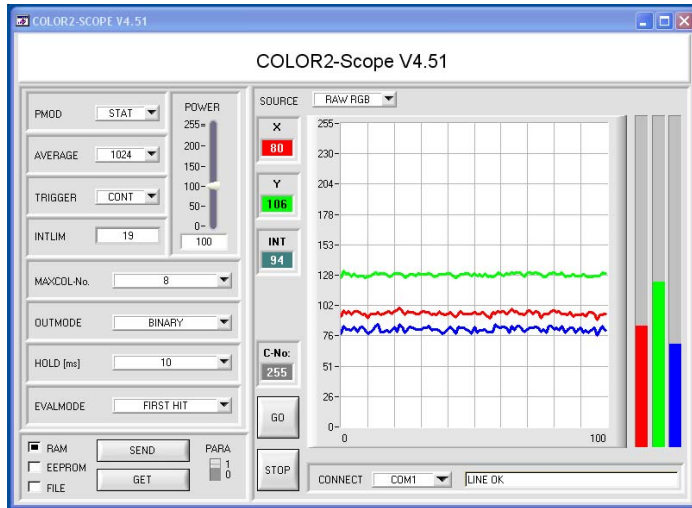

Display of the current raw data (red, green, blue) from the color sensor in „scroll mode“ (oscilloscope function). In addition the current raw data are visualized as a bar display. This facilitates the adjustment of the color sensor.

Parameter setting:

Among others the following parameters can be set:

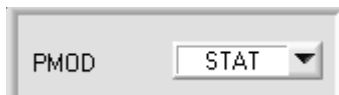

PMOD:
In this function field the operating mode of automatic light power control at the transmitter unit (white-light LED) can be set.
STAT: The LED transmission power is constantly kept at the value set with the POWER slider.
DYN: The LED transmission power is dynamically controlled in accordance with the amount of radiation that is diffusely reflected from the object.

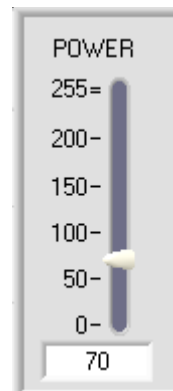

POWER:
With this slider the intensity of the white-light transmitter LED at the sensor can be adjusted.



AVERAGE:
Averaging (over 32768 scanning values max.). Here the number of scanning values over which the raw signal measured at the receiver is averaged can be set.

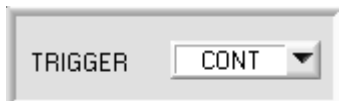

TRIGGER:
In this function field the trigger mode at the color sensor can be set.
EXT: Color detection is activated through the external trigger input (INO).
CONT: Continuous color detection (no trigger event required).



INTLIM:
This edit box is used for setting a lower intensity limit. Color evaluation is stopped if the total intensity of the three primary colors (red, green, blue) that is measured at the receiver unit falls below this limit.

Parameterization

MAXCOL-No.

HOLD [ms]

EVALMODE

MAXCOL-No.:

In this function field the number of colors to be checked can be set. With the color sensor a maximum of 15 colors can be checked.

HOLD:

In this edit box a pulse lengthening (100 ms max.) at the digital outputs of the color sensor can be set.

EVALMODE:

In this function field the evaluation mode at the color sensor can be set:

FIRST HIT: The current color value (X,Y) lies within the tolerance circle of a taught color.

MINIMAL DIST: The current color value (X,Y) is assigned to the teach-in color that lies next to this color value (X,Y) in the color triangle.

COLOR SERIES: Checking of the color sequence.

CONTRAST: Intensity check of a selected primary color (red, green, blue) with a maximum switching frequency of 28 kHz.

EXT TEACH: Teaching procedure is started by setting the input to 0V for instance via PLC, or push button). The integrated yellow LED indicates the successful teaching procedure.

ADAPTIVE CONTROL: Permanent teaching during measurement, adaptation to product fluctuations.

No.	X	Y	CTO	INT	ITO	
0	63	99	10	177	10	Blue
1	60	118	10	47	10	Red
2	101	69	10	50	10	Black
3	56	97	10	99	10	Pink
4	71	119	10	116	10	Green
5	56	60	10	40	10	Yellow
6	81	99	10	66	10	Olive
7	65	122	10	119	10	Purple
8	66	79	10	139	10	Cyan
9	88	62	10	65	10	Magenta
10	1	1	1	1	1	Dark Purple
11	1	1	1	1	1	Bright Magenta
12	1	1	1	1	1	Bright Green
13	1	1	1	1	1	Dark Teal
14	59	64	10	67	10	Dark Red

TEACH DATA TO No.: Inc

APPLY FROM ALL ZOOM

AUTO ADJUST RESET TABLE

COLOR TEACH TABLE:

Input of parameters X, Y, CTO, INT, and ITO in the corresponding input fields, or automatically by clicking the **TEACH DATA TO** button.



- X: X-value of the teach-in color, normalized red color content
- Y: Y-value of the teach-in color, normalized green color content
- CTO: Tolerance circle around the teach color that is defined as (X,Y) point
- INT: Teach-in value for the total intensity
- ITO: Intensity tolerance around the INT teach-in value

Each of the color ranges defined in the color teach table is represented as a tolerance circle around the teach-in color (X,Y) after a click on the **APPLY FROM ALL** button.



The tolerance circle around the teach-in color (X,Y) is specified by entering „CTO“.

"COLOR TRIANGLE":

In the color triangle the currently detected color is represented by an X,Y value pair, with the X-value representing the normalized red content, and the Y-value representing the normalized green content of the teach-in color.

The blue content on the color triangle is proportional to the distance of the X,Y value pair from the hypotenuse.

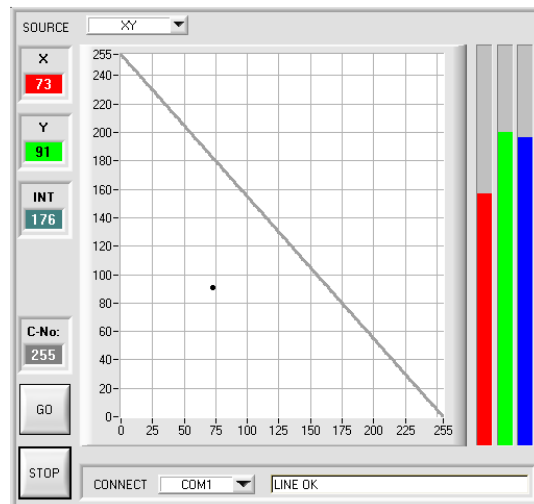
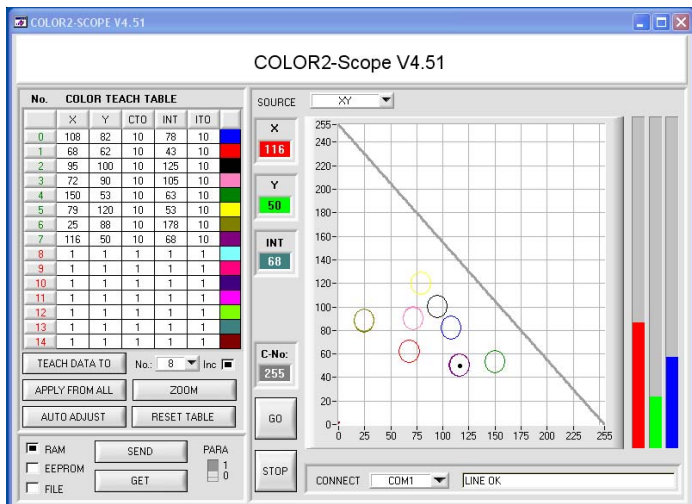

$$X = \frac{R}{R+G+B} * 255$$

$$Y = \frac{G}{R+G+B} * 255$$



Diagrams

Diagrams: INTENSITY
SI-COLO2-80-d1
DYN-Mode

INTENSITY [distance], typ.
DYN-Mode
Object 10° inclined
to the horizontal

Color: RAL 3020 (traffic red)

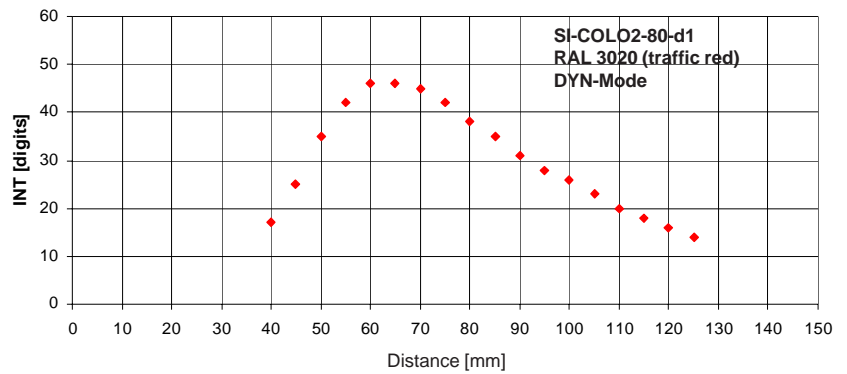

SI-COLO2-80-d1
RAL 1026 (luminous yellow)
DYN-Mode

INTENSITY [distance], typ.
DYN-Mode
Object 10° inclined
to the horizontal

Color: RAL 1026 (luminous yellow)

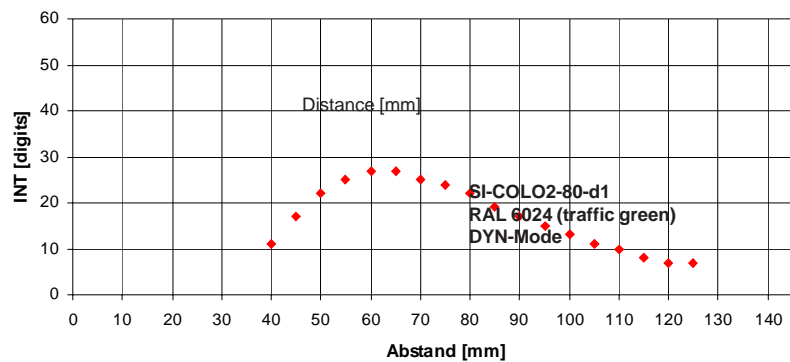

INTENSITY [distance], typ.
DYN-Mode
Object 10° inclined
to the horizontal

Color: RAL 6024 (traffic green)

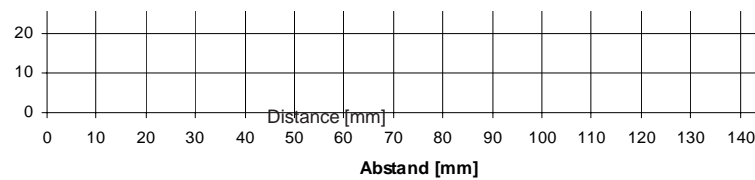

INTENSITY [distance], typ.
DYN-Mode
Object 10° inclined
to the horizontal

Color: RAL 5017 (traffic blue)

SI-COLO2-80-d1
RAL 5017 (traffic blue)
DYN-Mode

Distance [mm]



Diagrams

Diagrams: INTENSITY
SI-COLO2-80-d2
DYN-Mode

INTENSITY [distance], typ.
DYN-Mode
Object 10° inclined
to the horizontal

Color: RAL 3020 (traffic red)

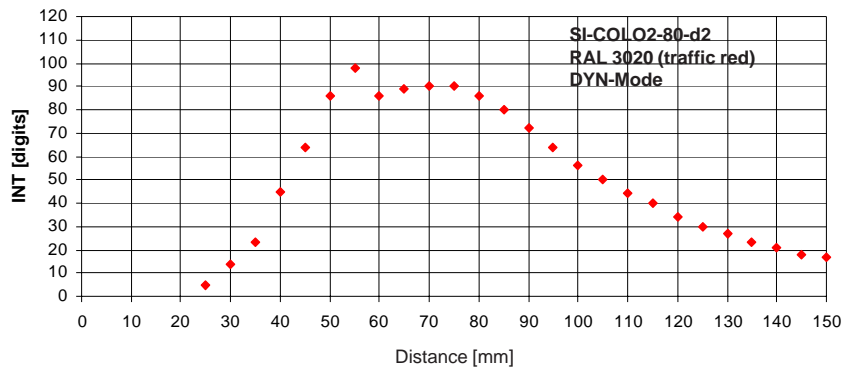

INTENSITY [distance], typ.
DYN-Mode
Object 10° inclined
to the horizontal

Color: RAL 1026 (luminous yellow)

SI-COLO2-80-d2
RAL 1026 (luminous yellow)
DYN-Mode

Distance [mm]



INTENSITY [distance], typ.
DYN-Mode
Object 10° inclined
to the horizontal

Color : RAL 6024 (traffic green)

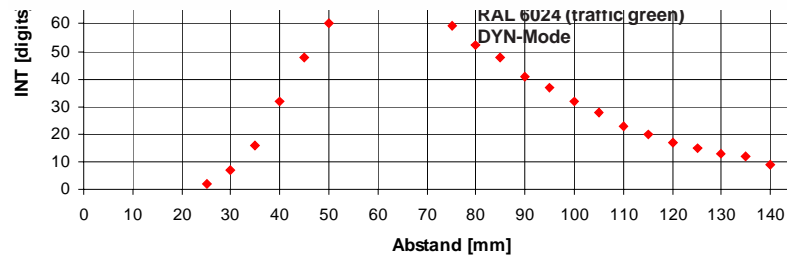

Distance [mm]

INTENSITY [distance], typ.
DYN-Mode
Object 10° inclined
to the horizontal

Color: RAL 5017 (traffic blue)

SI-COLO2-80-d2
RAL 5017 (traffic blue)
DYN-Mode

Distance [mm]

▶ **Diagrams**

Diagrams: INTENSITY
SI-COLO2-80-d3
DYN-Mode

INTENSITY [distance], typ.
DYN-Mode
Object 10° inclined
to the horizontal

Color: RAL 3020 (traffic red)

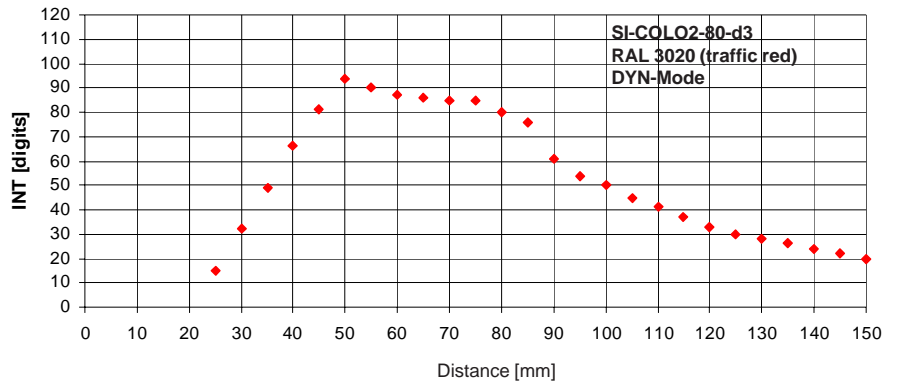

INTENSITY [distance], typ.
DYN-Mode
Object 10° inclined
to the horizontal

Color: RAL 1026 (luminous yellow)

SI-COLO2-80-d3
RAL 1026 (luminous yellow)
DYN-Mode

Distance [mm]

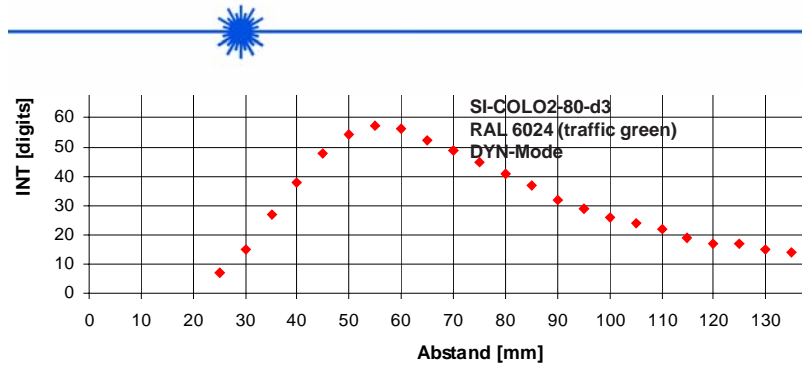

INTENSITY [distance], typ.
DYN-Mode
Object 10° inclined
to the horizontal

Color: RAL 6024 (traffic green)

Distance [mm]

SI-COLO2-80-d3
RAL 5017 (traffic blue)
DYN-Mode

INTENSITY [distance], typ.
DYN-Mode
Object 10° inclined
to the horizontal

Color: RAL 5017 (traffic blue)

Distance [mm]



Diagrams

Diagrams: INTENSITY
 SI-COLO2-80-...
 STAT-Mode
 Color: RAL 3020 (traffic red)

SI-COLO2-80-d1

INTENSITY [distance], typ.
 STAT-Mode (POWER=255)
 Object 10° inclined
 to the horizontal

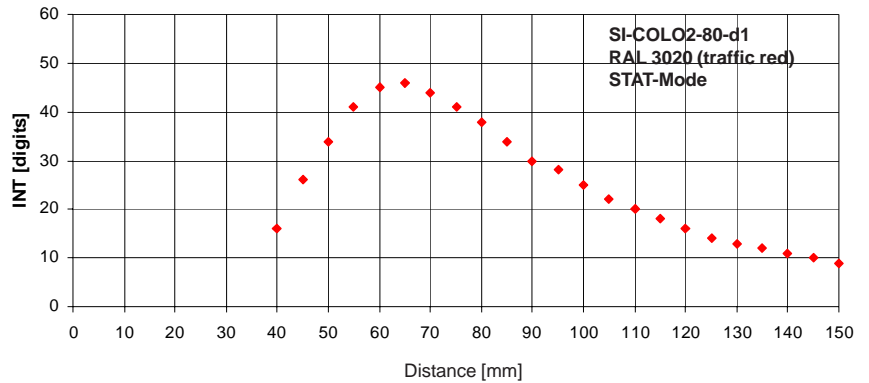

SI-COLO2-80-d2

INTENSITY [distance], typ.
 STAT-Mode (POWER=255)
 Object 10° inclined
 to the horizontal

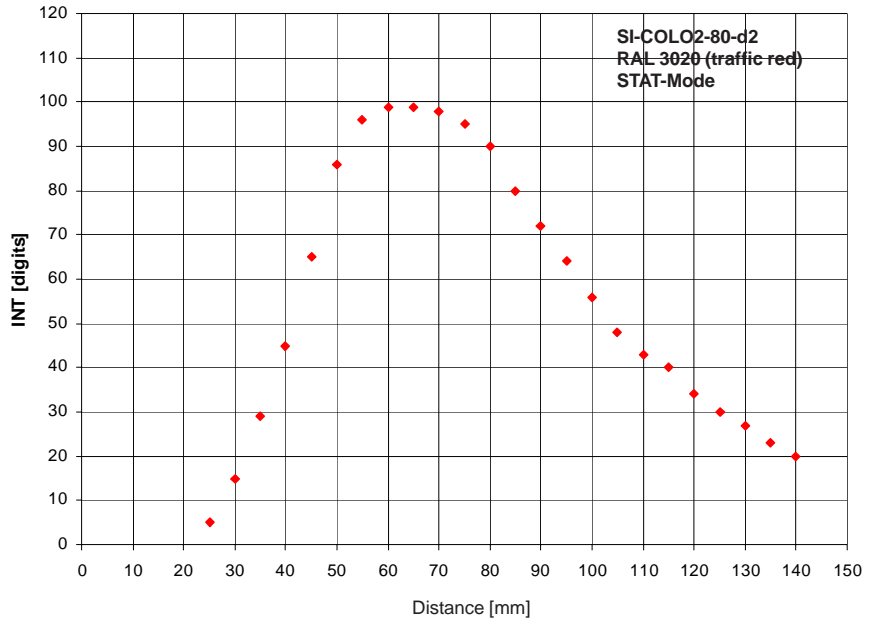

SI-COLO2-80-d3

INTENSITY [distance], typ.
 STAT-Mode (POWER=255)
 Object 10° inclined
 to the horizontal

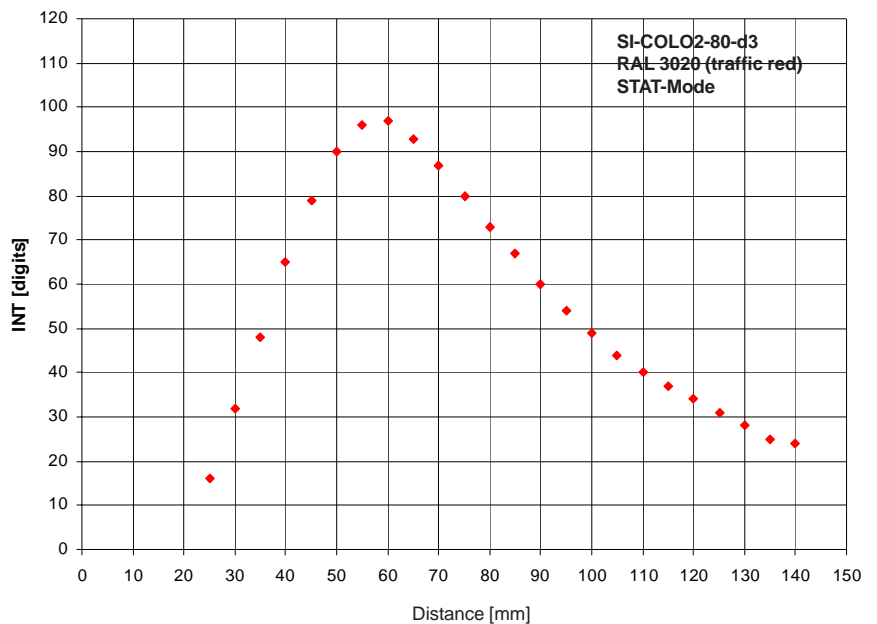



Diagrams

Diagrams: TEMPERATURE
SI-COLO2-80-... (all types)

COLOR VALUE [temperature], typ.
DYN-Mode
Object 10° inclined
to the horizontal
Object distance 80 mm

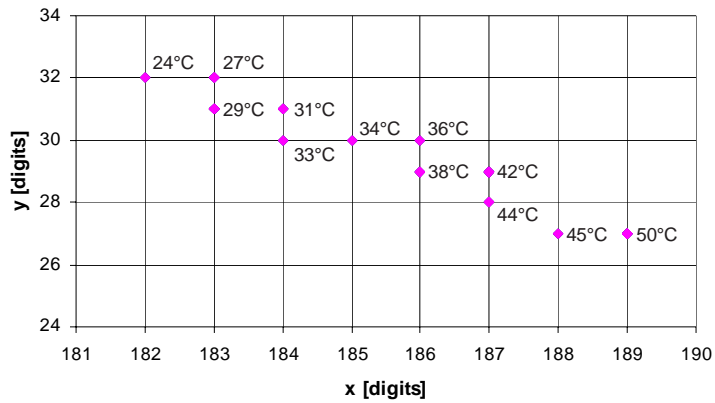

INTENSITY [temperature], typ.
DYN-Mode
Object 10° inclined
to the horizontal
Object distance 80 mm

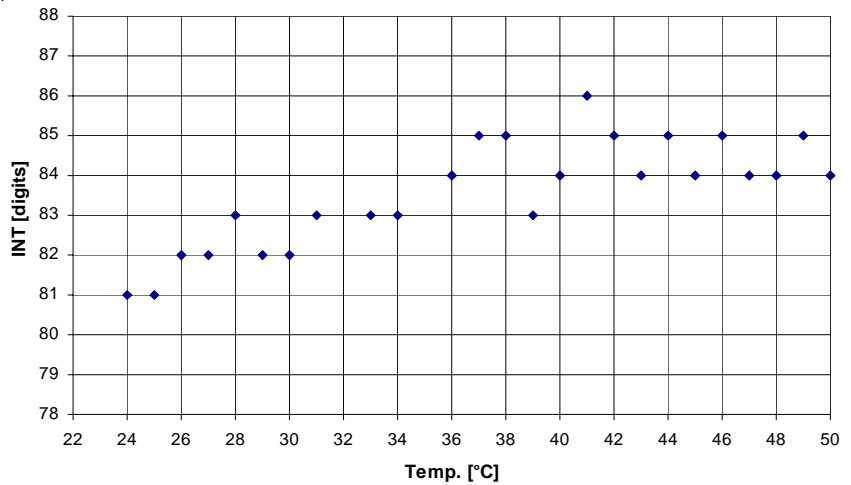

COLOR VALUE [temperature], typ.
STAT-Mode
Object 10° inclined
to the horizontal
Object distance 80 mm

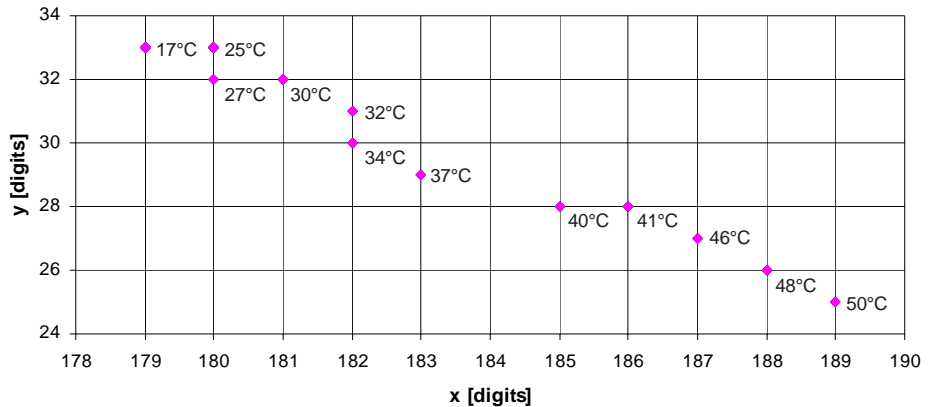

INTENSITY [temperature], typ.
STAT-Mode
Object 10° inclined
to the horizontal
Object distance 80 mm

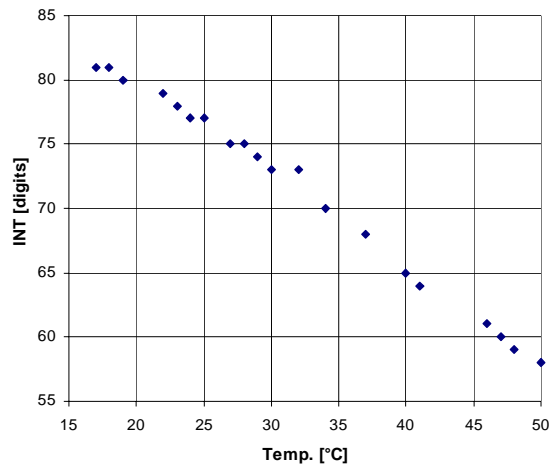



Diagrams

Diagrams: SPOT SIZE (DIAMETER)
SI-COLO2-80-...

Spot size in diameter at reference distance 80 mm:

- SI-COLO2-80-d1: 6.5 mm (typ.)
- SI-COLO2-80-d2: 9.0 mm (typ.)
- SI-COLO2-80-d3: 13.0 mm (typ.)

SI-COLO2-80-d1

SPOT DIAMETER [distance], typ.

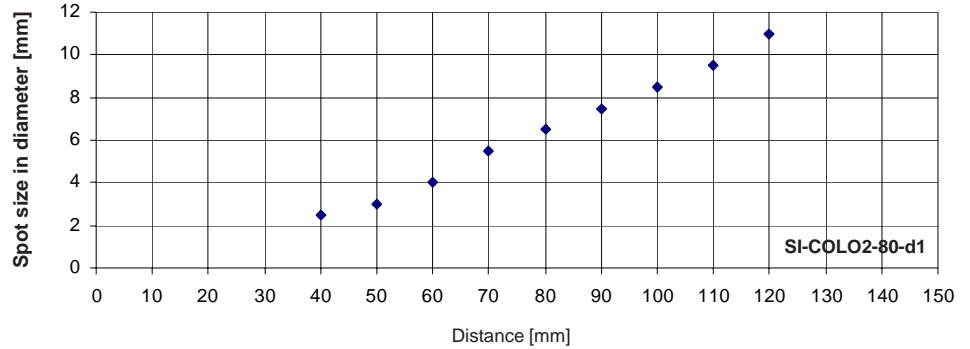

SI-COLO2-80-d2

SPOT DIAMETER [distance], typ.

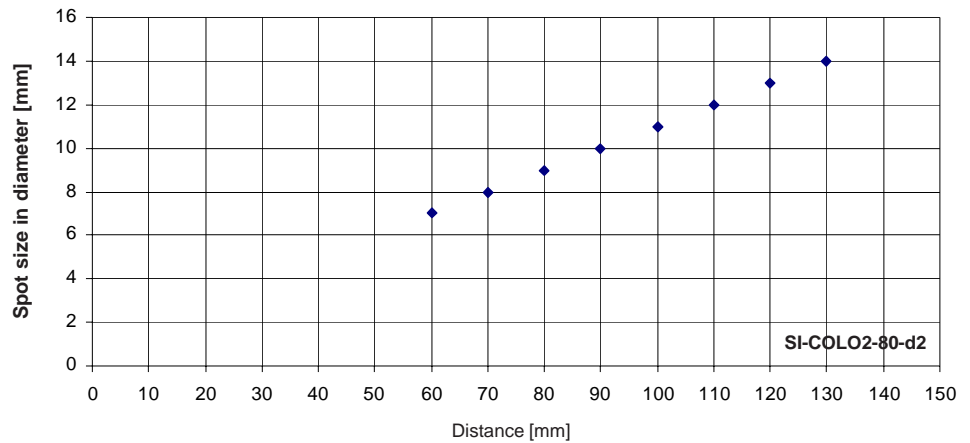

SI-COLO2-80-d3

SPOT DIAMETER [distance], typ.

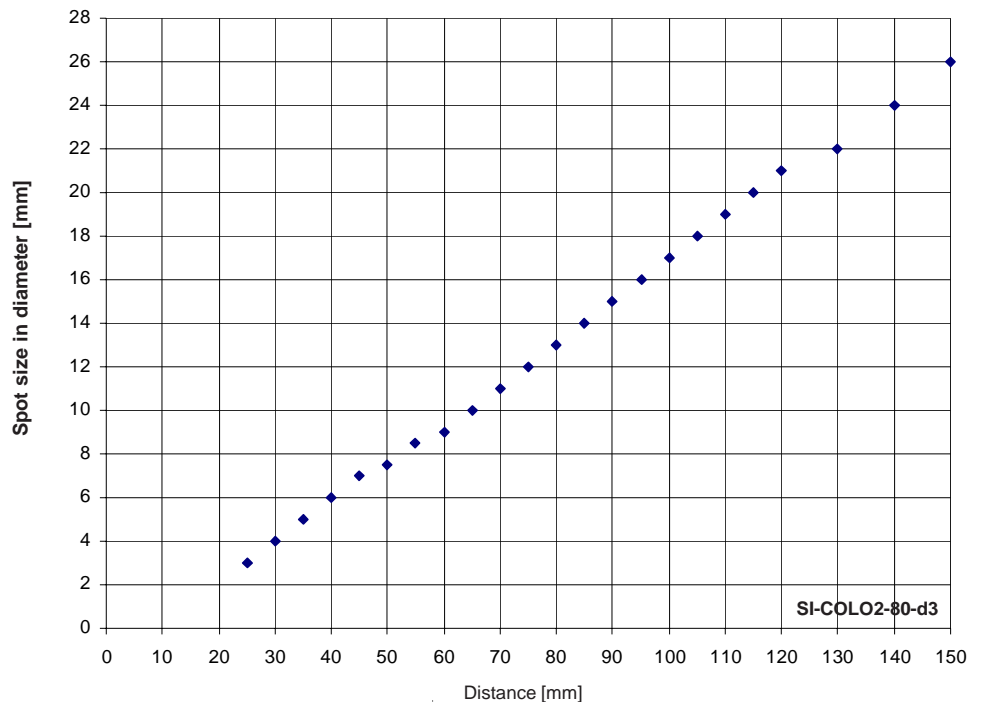



Accessories

Blast air attachment COL-BL-80
(please order separately)

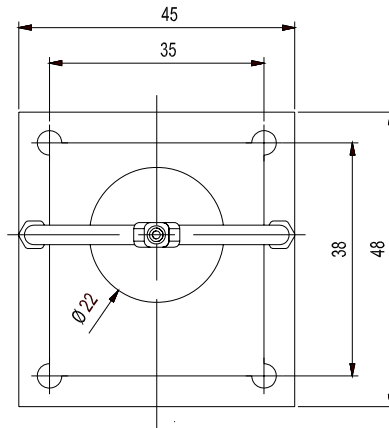
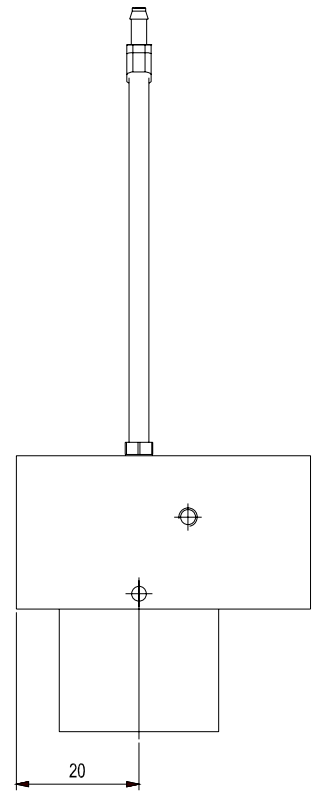
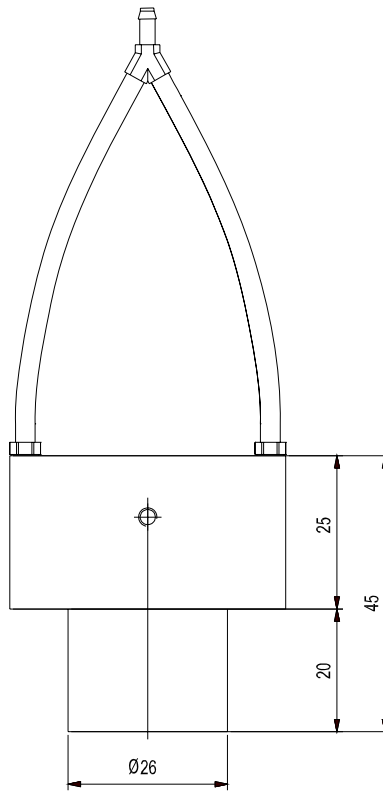
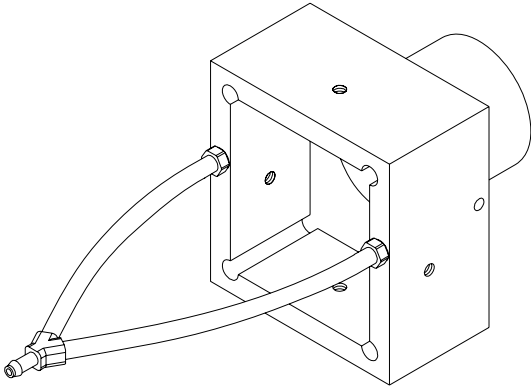

All dimensions in mm

COL-BL-80 mounted onto SI-COLO2-80:

