

SI-COLO Series

▶ SI-COLO2-LWL-ACL-MUX08

This sensor is mainly used to check luminous objects as for instance LEDs in view of color and luminosity

- Checking of LEDs as to intensity differences
- Checking of LEDs as to color differences
- Checking of bicolor and tricolor LEDs
- Up to 15 colors can be stored
- RS232 - interface (USB adapter available)
- External teaching through PLC, RS232, or push button
- 'Material adaptation' can be activated (adaptive control)
- Connectors for 8 fiber optic frontends (multiplexing)



Design

Product name:

SI-COLO2-LWL-ACL-MUX08

(Color sensor incl. software COLOR2-Scope)

R-P-AP1.0-1000-1X-Ms

(Fiber optic)

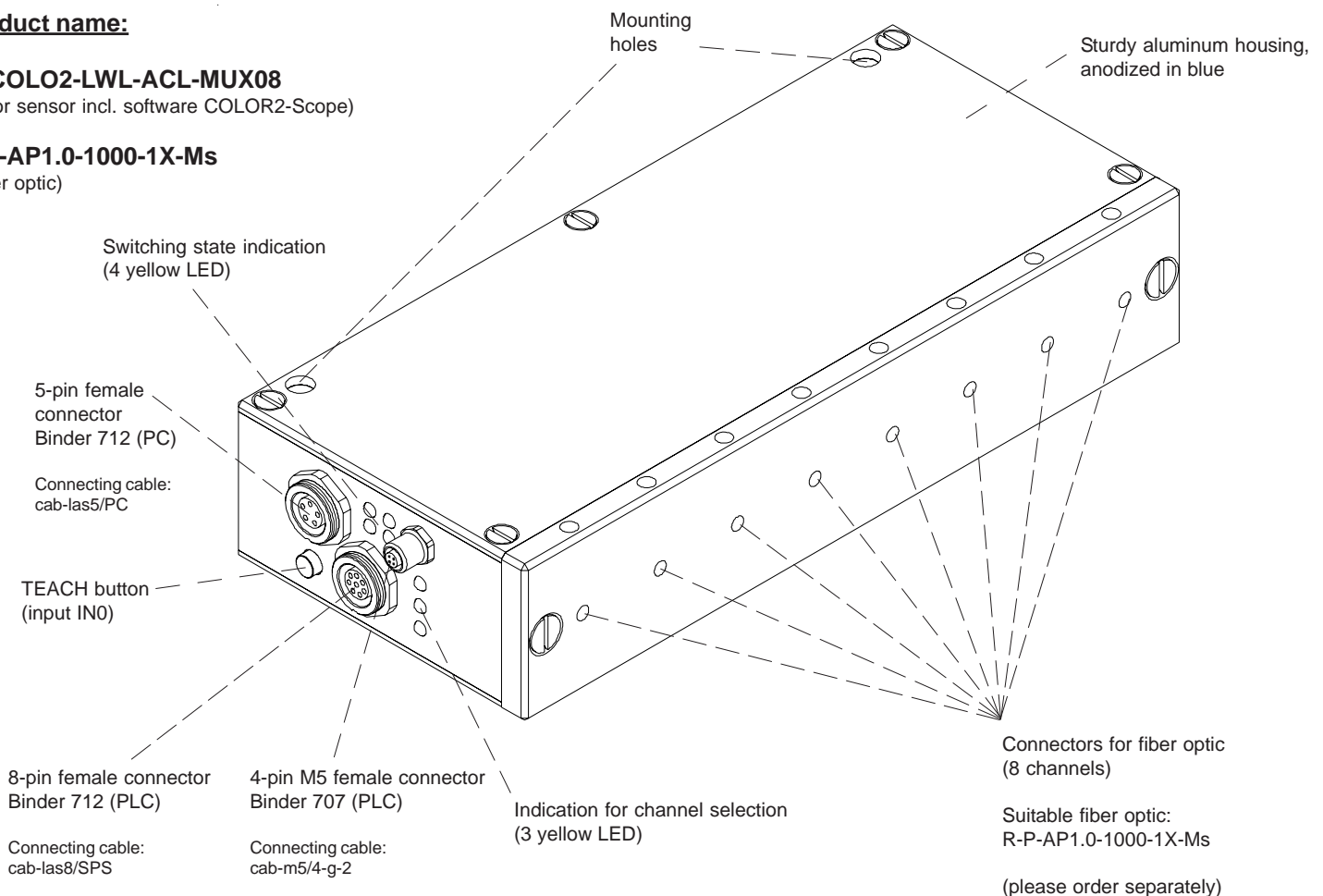

Parameterization under Windows® with software COLOR2-Scope:

The reflex color sensor SI-COLO2-LWL-ACL-MUX08 can be parameterized via serial interface (RS232) under Windows® (please cf. pages 5-7). Up to 15 colors can be taught, and stored in the sensor. If the sensor detects one of the taught colors, a change of switching state is performed through 4 encoded digital outputs (visual display by means of 4 yellow LEDs at the housing).



Technical Data

Model	SI-COLO2-LWL-ACL-MUX08 ("Active Light")
Light source	The measuring object itself serves as a light source (8x)
Reproducibility	In the x,y color range 1 digit each with 8 bit A/D conversion
Object distance	with optical fiber: typ. 2 mm ... 10 mm (depends on the light source to be measured)
Receiver	8x 3-color filter detector
Type of protection	IP54
Current consumption	typ. 180 mA
Interface	RS232, parameterizable under Windows®
Connector type	Connection to PLC: 8-pin female connector (Binder Series 712) Connection to PLC: 4-pin female M5 connector (Binder Series 707) Connection to PC: 5-pin female connector (Binder Series 712)
EMC test acc. to	IEC - 801...
Housing	Aluminum, anodized in blue
Operating temperature range	-20°C ... +55°C
Storage temperature range	-20°C ... +85°C
Pulse lengthening	Adjustable under Windows® 0 ms ... 100 ms
Max. switching current	100 mA, short-circuit-proof
Switching frequency	Max. 10 kHz (depends on number of colors to be taught and average setting)
Outputs	OUT 0 to OUT 3
Averaging	Over 32768 values max.
Voltage supply	+12VDC ... +30VDC, protected against polarity reversal, overload-protected
Switching state display	Visualization by means of 4 yellow LEDs
Color memory capacity	Non-volatile EEPROM with parameter sets for 15 colors max.
Optical fibers	8 fiber optics of type R-P-AP1.0-1000-1X-Ms
Teach button	for external teaching of color reference values via input IN0



Dimensions

SI-COLO2-LWL-ACL-MUX08

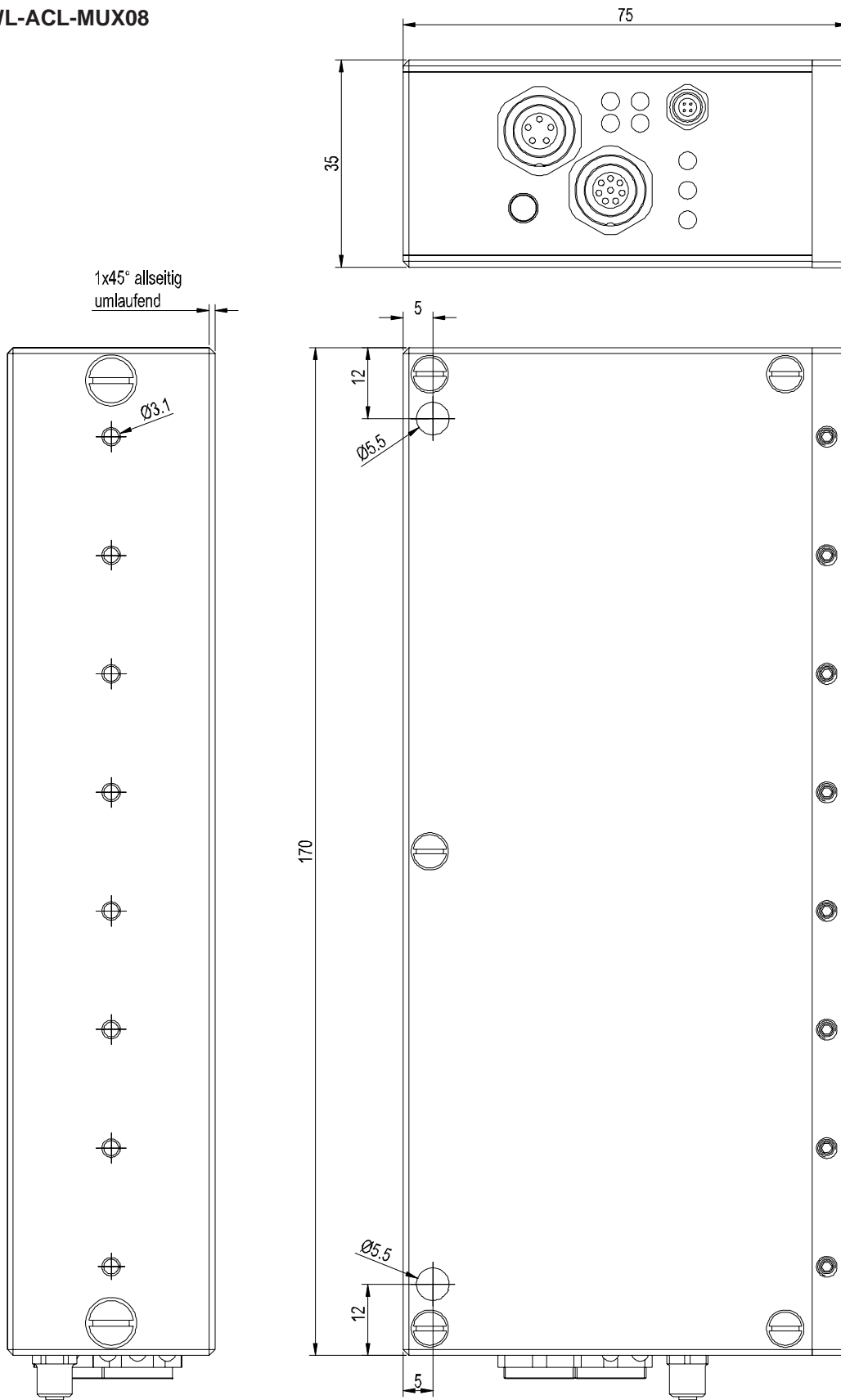

All dimensions in mm



Connector Assignment

Connection of SI-COLO2-LWL-ACL-MUX08 to PLC:

8-pin fem. connector Binder 712

Pin:	Color:	Assignment:
1	wht	0V (GND)
2	brn	+12 ... +30 VDC
3	grn	IN0
4	yel	OUT0
5	gry	OUT1
6	pnk	OUT2
7	blu	OUT3
8	red	n.c.

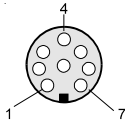

Connecting cable:
cab-las8/SPS

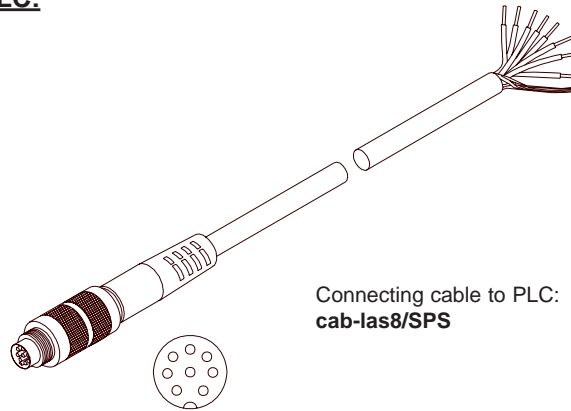

Connecting cable to PLC:
cab-las8/SPS

Connection of SI-COLO2-LWL-ACL-MUX08 to PC:

5-pin fem. connector Binder 712

Pin:	Assignment:
1	0V (GND)
2	TX0
3	RX0
4	n.c.
5	n.c.

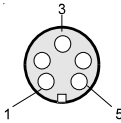

Connecting cable:
cab-las5/PC

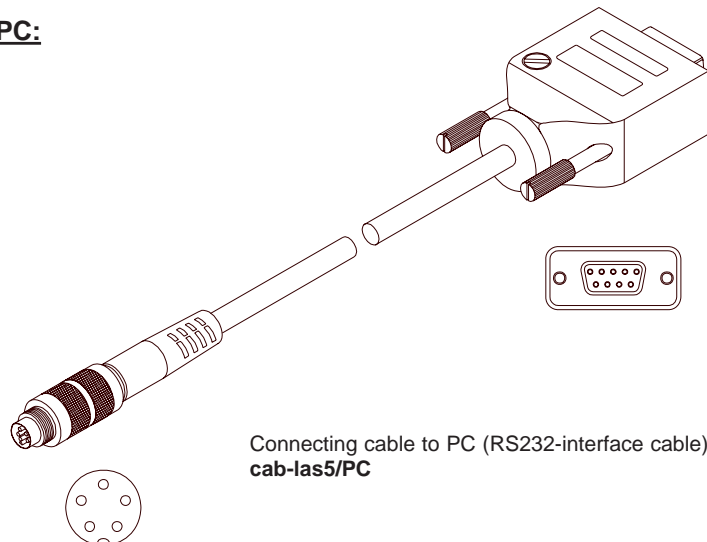

Connecting cable to PC (RS232-interface cable):
cab-las5/PC

Connection of SI-COLO2-LWL-ACL-MUX08 to PLC:

4-pin fem. connector Binder Serie 707

Pin:	Color:	Assignment:
1	brn	S0 (+5V ... +24V)
2	wht	0V (GND)
3	blu	S2 (+5V ... +24V)
4	blk	S1 (+5V ... +24V)

Connecting cable:
cab-M5/4-g-2

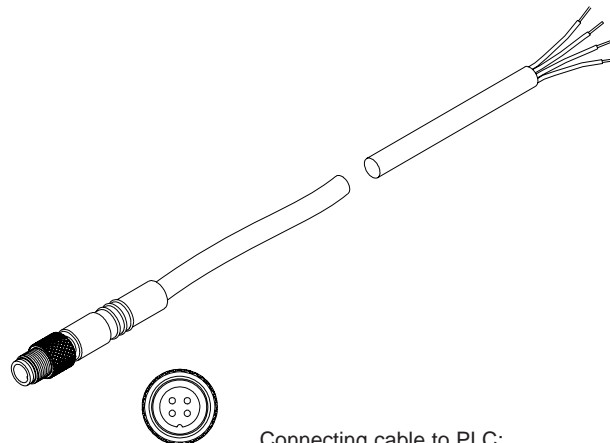

Connecting cable to PLC:
cab-M5/4-g-2

Measuring Principle
Measuring principle:

With the help of the light source to be examined part of the emitted light is coupled into a plastic fiber bundle and directed onto a color-sensitive detector element. The received light is separated according to the 3-color-range process (red, green, blue).

Parameterization
Parameterization under Windows® with software COLOR2-Scope:

The SI-COLO2-LWL-ACL-MUX08 reflex color sensor is parameterized under Windows® with the COLOR2-Scope software. The RS232 interface is used for setting parameters such as:

- Averaging over a maximum of 32768 values
- Number of colors to be checked
- Pulse lengthening up to 100ms max.
- External or continuous trigger
- Minimum intensity required for color evaluation

Visualization:

Under Windows® representation of the color value on a PC in numeric form and in a color chart, and representation of RGB values in a time chart. In addition the current RGB values are displayed as a bar chart.

The following evaluation algorithms can also be selected:

- Target lies within the color tolerance circle of a taught color and within an intensity window (FIRST HIT)
- Determination of the taught color that is most similar to the target (minimum distance between target color and reference color in the color chart) (MINIMAL DIST)
- Checking of the target's color series with a taught color sequence (SENSOR SERIES)
- Contrast check of the target. In this case only one primary color (freely selectable) is used for evaluation (CONTRAST)
Advantage: Possibility of using a very high scanning rate of up to 28 kHz.
- EXTERN TEACH: With this function field the color sensor can be taught by means of a LOW-signal at pin 3 (for instance via push button, or PLC). During this procedure the object to be taught has to be in the visibility range of the color sensor. The yellow LEDs indicate a successful teaching procedure.
- ADAPTIVE CONTROL: During measurement the sensor permanently teaches itself the current setpoint value, i.e. it adapts itself to possible product fluctuations.

LED-Display:

The color code is visualized by means of 4 yellow LEDs at the housing of the SI-COLO2-LWL-ACL-MUX08 reflex color sensor. At the same time the color code indicated at the LED display is output as 4-bit binary information at the digital outputs OUT0 to OUT3 of the 8-pin SI-COLO2/PLC connector.

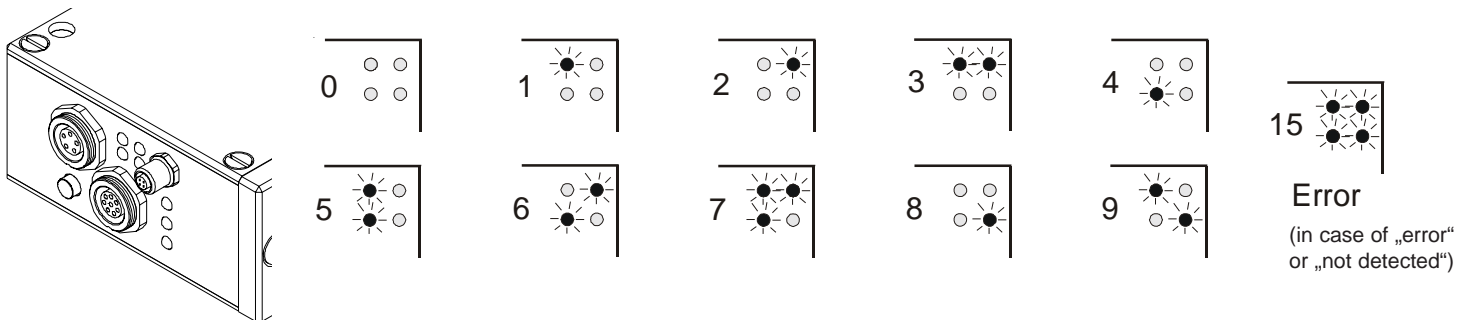

In the DIRECT mode the maximum numbers of colors to be taught is 4 (color no. 0,1,2,3). These 4 colors can be directly output at the 4 digital outputs. The respective detected color is displayed by means of the 4 yellow LEDs at the color sensor housing.



Parameterization

Windows® user interface:

The Windows® user interface facilitates the teach-in process at the SI-COLO2-LWL-ACL-MUX08 reflex color sensor and supports the operator in the task of adjustment and commissioning of the color sensor.

X,Y-chart:

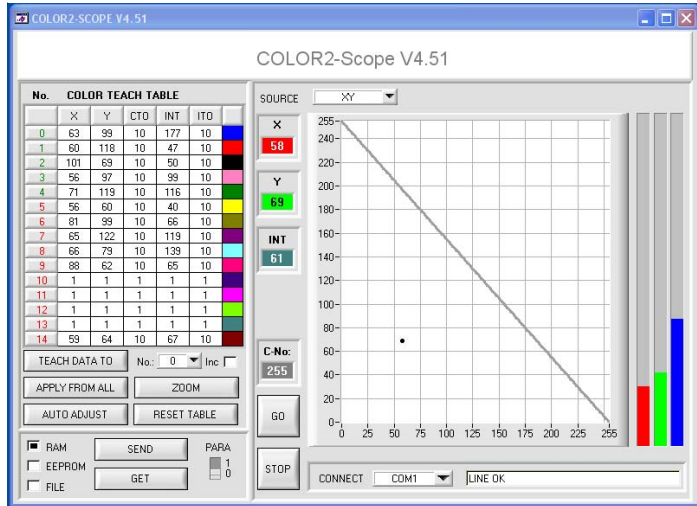

The color value is displayed graphically by way of the X,Y-color triangle and also in the numerical output fields. The current raw data (red, green, blue) from the color detector are visualized in a bar chart. If a color is detected during measuring operation, the currently detected color is displayed in a numeric output field:

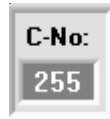

RGB-t-chart:

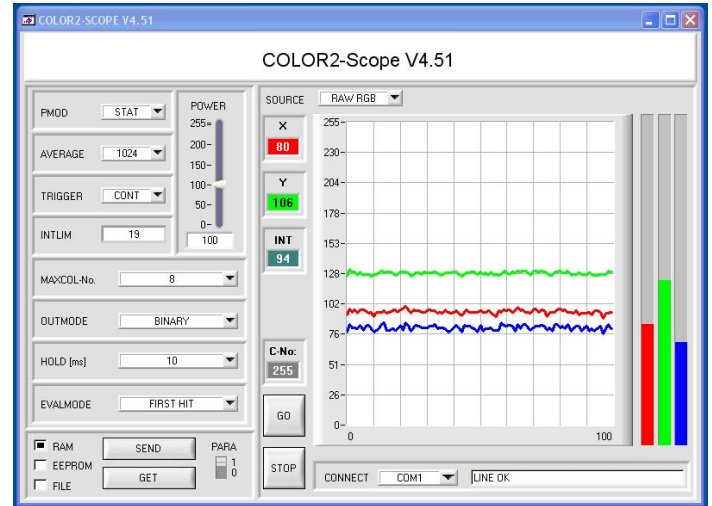

Display of the current raw data (red, green, blue) from the color sensor in „scroll mode“ (oscilloscope function). In addition the current raw data are visualized as a bar display. This facilitates the adjustment of the SI-COLO2-LWL-ACL-MUX08 reflex color sensor.

Parameter setting:

Among others the following parameters can be set:



AVERAGE:
Averaging (over 32768 scanning values max.). Here the number of scanning values over which the raw signal measured at the receiver is averaged can be set.



TRIGGER:
In this function field the trigger mode at the SI-COLO2-LWL-ACL-MUX08 color sensor can be set.
EXT: Color detection is activated through the external trigger input (IN0).
CONT: Continuous color detection (no trigger event required).



INTLIM:
This edit box is used for setting a lower intensity limit. Color evaluation is stopped if the total intensity of the three primary colors (red, green, blue) that is measured at the receiver unit falls below this limit.

Parameterization

MAXCOL-No.

HOLD [ms]

EVALMODE

No.	X	Y	CTO	INT	ITO	
0	63	99	10	177	10	Blue
1	60	118	10	47	10	Red
2	101	69	10	50	10	Black
3	56	97	10	99	10	Pink
4	71	119	10	116	10	Green
5	56	60	10	40	10	Yellow
6	81	99	10	66	10	Olive
7	65	122	10	119	10	Purple
8	66	79	10	139	10	Cyan
9	88	62	10	65	10	Magenta
10	1	1	1	1	1	Dark Purple
11	1	1	1	1	1	Bright Magenta
12	1	1	1	1	1	Bright Green
13	1	1	1	1	1	Dark Teal
14	59	64	10	67	10	Dark Red

TEACH DATA TO No.: Inc

APPLY FROM ALL ZOOM

AUTO ADJUST RESET TABLE

MAXCOL-No.:

In this function field the number of colors to be checked can be set. With the SI-COLO2-LWL-ACL-MUX08 reflex color sensor a maximum of 15 colors can be checked.

HOLD:

In this edit box a pulse lengthening (100 ms max.) at the digital outputs of the SI-COLO2-LWL-ACL-4X reflex color sensor can be set.

EVALMODE:

In this function field the evaluation mode at the SI-COLO2-LWL-ACL-4X reflex color sensor can be set:

FIRST HIT:

The current color value (X,Y) lies within the tolerance circle of a taught color.

MINIMAL DIST:

The current color value (X,Y) is assigned to the teach-in color that lies next to this color value (X,Y) in the color triangle.

COLOR SERIES:

Checking of the color sequence.

CONTRAST:

Intensity check of a selected primary color (red, green, blue) with a maximum switching frequency of 28 kHz.

EXT TEACH:

Teaching procedure is started by setting the input to 0V for instance via PLC, or push button). The integrated yellow LED indicates the successful teaching procedure.

ADAPTIVE CONTROL:

Permanent teaching during measurement, adaptation to product fluctuations.

COLOR TEACH TABLE:

Input of parameters X, Y, CTO, INT, and ITO in the corresponding input fields, or automatically by clicking the **TEACH DATA TO** button.



X: X-value of the teach-in color, normalized red color content

Y: Y-value of the teach-in color, normalized green color content

CTO: Tolerance circle around the teach color that is defined as (X,Y) point

INT: Teach-in value for the total intensity

ITO: Intensity tolerance around the INT teach-in value

Each of the color ranges defined in the color teach table is represented as a tolerance circle around the teach-in color (X,Y) after a click on the **APPLY FROM ALL** button.



The tolerance circle around the teach-in color (X,Y) is specified by entering „CTO“.

"COLOR TRIANGLE":

In the color triangle the currently detected color is represented by an X,Y value pair, with the X-value representing the normalized red content, and the Y-value representing the normalized green content of the teach-in color.

The blue content on the color triangle is proportional to the distance of the X,Y value pair from the hypotenuse.

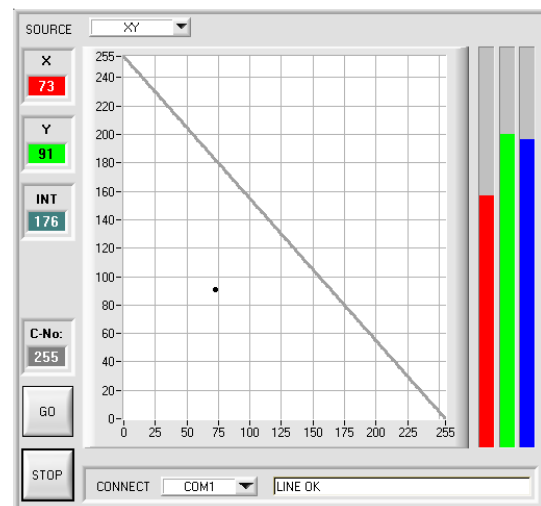
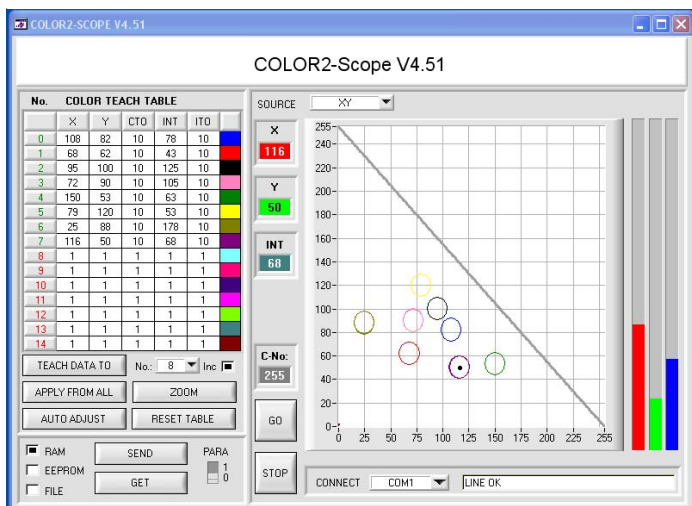

**Fiber Optic**

R-P-AP1.0-1000-1X-Ms
Reflex fiber optic with end sleeve made of brass
(please order separately)

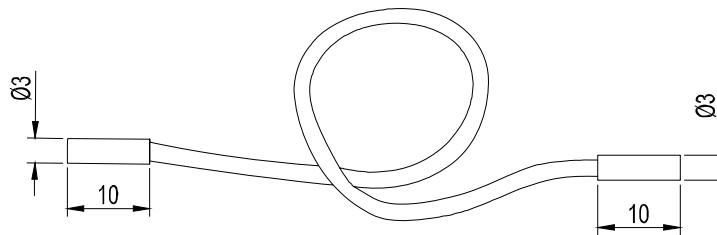
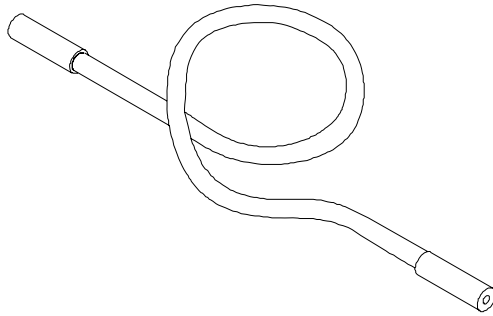

All dimensions in mm