

# Manual

## Software FLB-TLB-CON8-Scope V3.0

(PC-Software for Microsoft® Windows® XP, Me, 2000)

**for electronic control units  
FLB-CON8 or TLB-CON8-FIO-IR**

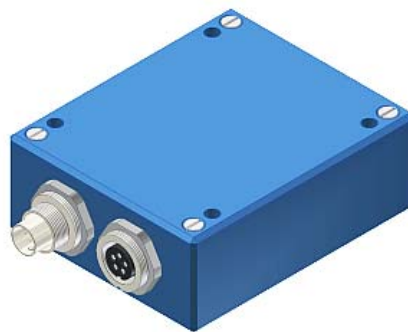

This manual describes installation and commissioning of the PC software for the electronic control unit FLB-CON8 or TLB-CON8-FIO-IR.

The products FLB-F, FLB-H, and FLB-V of the FLB Series respectively the products FKB-...-P and SLB-...-P of the TLB Series can be connected to the electronic control unit FLB-CON8 or TLB-CON8-FIO-IR. The electronic control unit guarantees a stable voltage supply for the respective transmitter/receiver of the FLB or TLB Series.

The electronic control unit also amplifies and processes the analog signal of the receiver in a suitable manner. A micro-controller performs 12-bit analog/digital conversion of the analog signal, allowing recording and evaluation of the signal characteristics at the sensor. Furthermore the electronic control unit offers various options for intelligent transmitting power control (dirt accumulation compensation) at the sensor.

Parameters and measured values can be exchanged between the PC and the electronic control unit through either the RS232 interface or Ethernet interface (by means of an Ethernet adapter). All the parameters can be stored in the non-volatile EEPROM of the electronic control unit through the interface. The FLB-TLB-CON8-Scope V3.0 Windows software facilitates parameterisation, diagnostics, and adjustment of the sensor system (oscilloscope function). The FLB-TLB-CON8-Scope V3.0 software furthermore features the function of a data recorder that automatically records data and saves them on the PC's hard disk.

The sensor system comprising sensor and electronic control unit is temperature-compensated in a range from 0°C to 80°C.

Firmware updates can be easily performed through the RS232 interface even when the sensor system is installed.

When parameterisation is finished, the electronic control unit continues to run in STAND-ALONE operation, without a PC.

## 0. Contents

	Page
1. Installation of the FLB-TLB-CON8-Scope software .....	3
2. Operation of the FLB/TLB -Scope software.....	4
2.1 Tab CONNECT .....	5
2.2 Tab PARA, Taste SEND, GET, GO, STOP (parameterization, data exchange) .....	7
2.3 Tab RECORDER (data recording) .....	11
2.4 Graphic display elements .....	13
3. Short instructions for the operation of FLB/TLB sensor systems with the FLB-TLB-CON8-Scope V3.0 software.....	14
4. Operation of the TEMPCOMP-Scope software .....	19
5. Connector assignment of the FLB-CON8 electronic control unit .....	20
6. Scan frequencies at different settings .....	21
7. RS232 communication protocol.....	22

**Shortcuts:**

SEND	F9
GET	F10
GO	F11
STOP	F12

# 1 Installation of the FLB-TLB-CON8-Scope software

Hardware requirements for successful installation of the FLB-TLB-CON8-Scope software:

- IBM PC AT or compatible
- VGA graphics
- Microsoft® Windows® XP, Me, 2000
- Serial RS232 interface at the PC
- Microsoft-compatible mouse
- Cable for the RS232 interface (cab-las5/PC)
- CD-ROM drive
- 20 MByte of free hard disk space

Please install the FLB-TLB-CON8-Scope software as described below:

The FLB-TLB-CON8-Scope software can only be installed under Windows. Windows must therefore be started first, if it is not yet running.

1. The software can be installed directly from the installation CD-ROM. To install the software, start the SETUP program in the INSTALL folder of the CD-ROM.
2. The installation program displays a dialog and suggests to install the software in the C:\[FILENAME] directory on the hard disk. You may accept this suggestion with **OK** or **[ENTER]**, or you may change the path as desired. Installation is then performed automatically.
3. During the installation process a new program group for the FLB-TLB-CON8-Scope software is created in the Windows Program Manager. In the FLB-TLB-CON8-Scope program group an icon for starting the software is created automatically. When installation is successfully completed the installation program displays "Setup OK".
4. After successful installation the software can be started with a left mouse button double-click on the FLB-TLB-CON8-SCOPE icon.

Windows™ is a trademark of the Microsoft Corp.  
MS-DOS® is a registered trademark of the Microsoft Corp.  
VGA™ is a trademark of the International Business Machines Corp.

## 2 Operation of the FLB-TLB-CON8-Scope software

Please read this chapter first before you start to adjust and parameterise the sensor system.

Pressing the right mouse button on an individual element will call up a short help text.

When the FLB-TLB-CON8-Scope software is started the following window appears on the Windows interface:

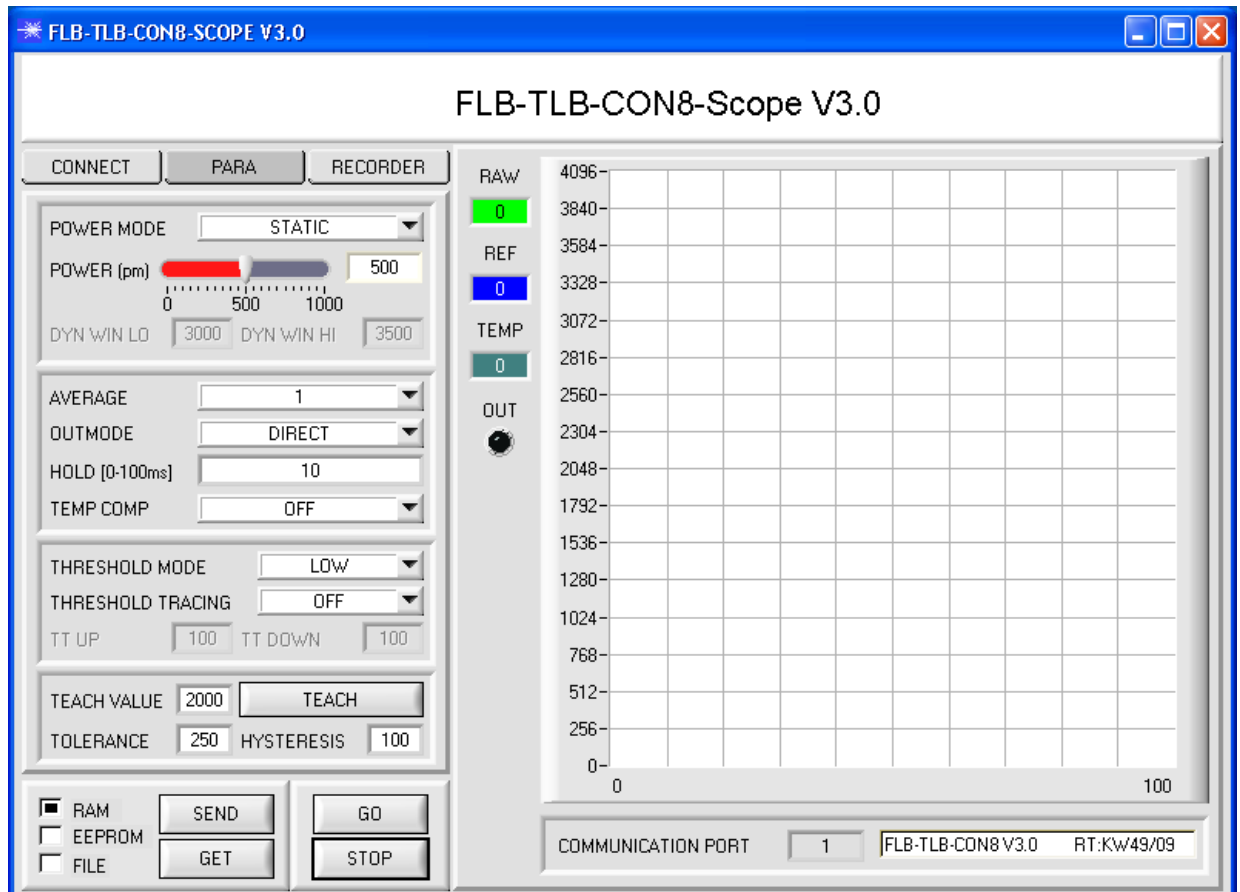

## 2.1 Tab CONNECT

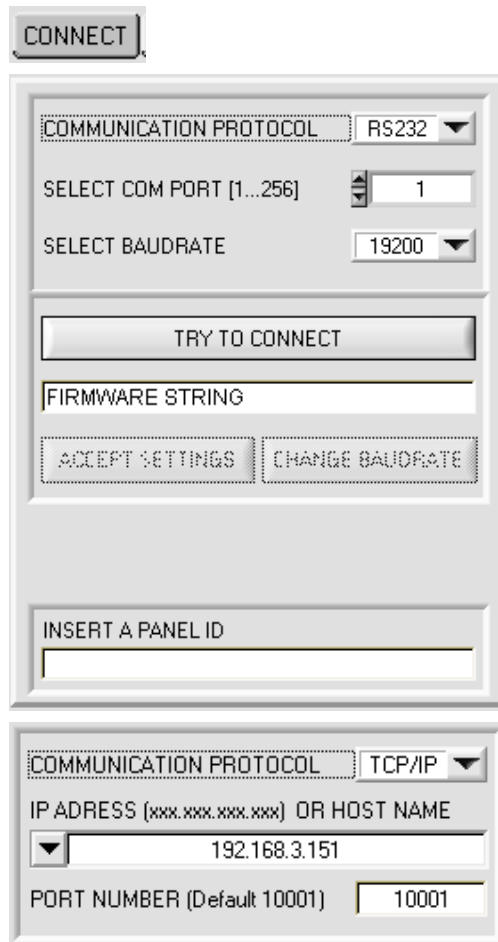

### CONNECT:

Pressing the **CONNECT** tab opens a window for selecting and configuring the interface.

The **COMMUNICATION PROTOCOL** function field is used for selecting either an **RS232** or a **TCP/IP** protocol. If **RS232** is selected, a port from 1 to 256 can be selected with **SELECT COM PORT**, depending on which port the sensor is connected to.

The sensor operates with a set baudrate that can be modified with **CHANGE BAUDRATE** (see below). The sensor and the user interface both must operate with the same baudrate. At the user interface the baudrate is set with **SELECT BAUDRATE**. If after starting the software should not automatically establish a connection, the correct baudrate can be found with **SELECT BAUDRATE**.

If an adaptor is used, the **COM PORT** number can be determined by way of the hardware manager in the system control panel.

If the sensor should communicate through a local area network, an RS232 to Ethernet adaptor will be needed. This adapter makes it possible to establish a connection to the sensor with the **TCP/IP** protocol.

The network adaptors that are available from us are based on the Lantronix XPort module. For parameterising these adaptors (assigning of an IP address, setting of the Baud rate of 19200) please download the "DeviceInstaller" software that is provided free of charge by Lantronix at <http://www.lantronix.com/>. DeviceInstaller is based on Microsoft's ".NET" framework. Detailed operating instructions for the "DeviceInstaller" software also are available from Lantronix.

In order to establish a connection to the adaptor, its IP address or HOST name must be entered in the field **IP ADDRESS (xxx.xxx.xxx.xxx) OR HOST NAME**. The DROP DOWN menu (down arrow) shows the last 10 IP addresses that were used. An address from this list can be directly selected by clicking on the respective item. The DROP DOWN list is saved and is thus always available when the software is closed.

The **PORT NUMBER** for the XPort-based network adaptors is 10001. This port number must not be changed.

When you press the **TRY TO CONNECT** button, the software tries to establish a connection with the set parameters. The communication status is shown in the display field. If the sensor answers with its FIRMWARE ID, the set connection type can be accepted by pressing **ACCEPT SETTINGS**. You will then be returned to the **PARA** tab. If you get a **TIMEOUT** message, the software could not establish a connection to the sensor. In this case please check if the interface cable is correctly connected, if the sensor is supplied with power, and if the set parameters are correct.

If a connection has been accepted by pressing **ACCEPT SETTINGS**, the software starts automatically with these settings when called the next time.

<p><b>Please note:</b></p>  <p><b>ATTENTION !</b></p>	<p><b>The stable function of the interface is a basic prerequisite for measured value transfer from the PC to the Sensor.</b></p> <p><b>Due to the limited data transfer rate through the serial RS232 interface only slow changes of the raw signals at the sensor front end can be observed in the graphic output window of the PC.</b></p> <p><b>For maintaining maximum switching frequency at the sensor data communication with the PC must be stopped (press the STOP button).</b></p>
--	---

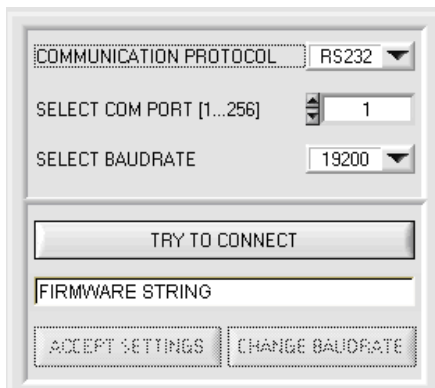

The baudrate for data transfer through the RS232 interface can be set by means of the **SELECT BAUDRATE** drop down menu and **CHANGE BAUDRATE** function field.

This is necessary if a high-speed connection is needed for data transfer through the serial interface.

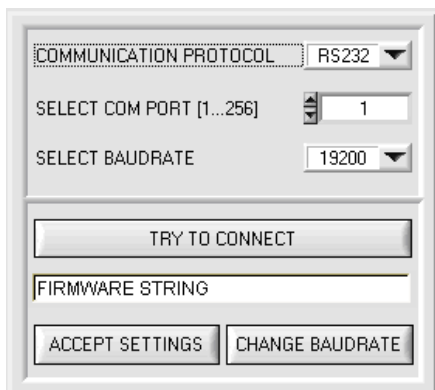

If the baudrate should be changed, a connection must first be established by clicking on **TRY TO CONNECT**.

The **CHANGE BAUDRATE** button will then be active.

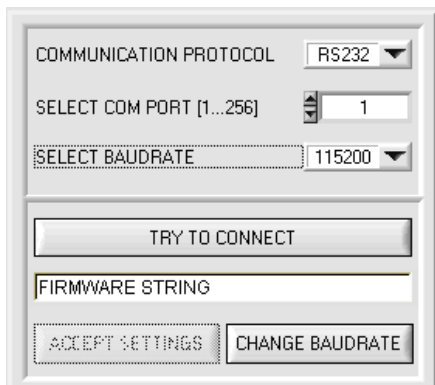

Now a new baudrate can be selected under **SELECT BAUDRATE**.

A click on **CHANGE BAUDRATE** sends the new baudrate information to the sensor.

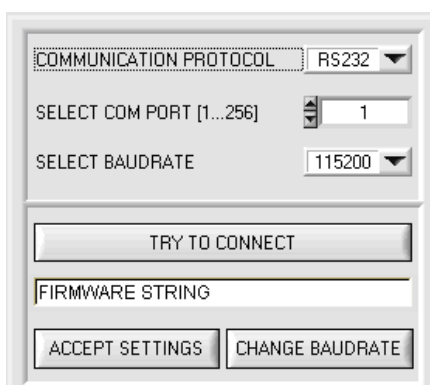

When the new baudrate information has been successfully sent, the sensor operates with the new baudrate. A window will pop up, prompting you to select **EEPROM** and then to press **SEND**. After a hardware reset the new baudrate only will be used when **EEPROM** and **SEND** have been pressed.

A click on **ACCEPT SETTINGS** saves the current interface settings, which will then be automatically set when the software is restarted.

## 2.2 Tab PARA, button SEND, GET, GO, STOP

### PARA:

Pressing the PARA tab opens a window for setting the sensor parameters.

### ATTENTION!

**A change of the parameter function groups only becomes effective at the sensor after actuation of the SEND button in the MEM function field!**

### SEND [F9]:

When the **SEND** button is clicked (or shortcut key button F9 is pressed), all the currently set parameters are transferred between PC and sensor. The target of the respective parameter transfer is determined by the selected button (**RAM**, **EEPROM**, or **FILE**).

### GET [F10]:

The currently set values can be interrogated from the sensor by clicking on the **GET** button (or with shortcut key button F10). The source of data exchange is determined by the selected button (**RAM**, **EEPROM**, or **FILE**).

### RAM:

After a click on the **SEND** button the current parameters are written into the **RAM** memory of the sensor, or they are read from the **RAM** by clicking on the **GET** button, i.e. these parameters are lost when the voltage at the sensor is switched off.

### EEPROM:

After a click on the **SEND** button the current parameters are written into the non-volatile memory of the **EEPROM** in the sensor, or they are read from the **EEPROM** by clicking on the **GET** button, i.e. the parameters in the internal **EEPROM** are stored when the voltage at the sensor is switched off.

### FILE:

After pressing **SEND**, the current parameters can be written to a selectable file on the hard disk. With **GET** parameters can be read from such a file. When the **SEND** or **GET** button is pressed, a dialog box opens for selecting the desired file.

### GO [F11]:

A click on this button (or with shortcut key button F11) starts data transfer from the sensor to the PC through the serial RS232 interface.

### STOP [F12]:

A click on this button (or with shortcut key button F12) stops data transfer from the sensor to the PC through the serial RS232 interface.

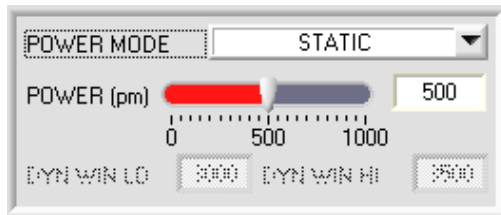

**POWER MODE:**

In this function field the operating mode of automatic power correction at the transmitter unit (transmitter LED) can be set.

**STATIC:** The transmitter power is constantly kept at the value set with the **POWER [pm]** slider (recommended operation mode). The **POWER** can be set with the slider or by entering a value in the edit-box. A value of 1000 means full intensity at the transmitter unit, a value of 0 sets the lowest intensity at the transmitter.

**DYNAMIC:** The transmitter power is dynamically controlled based on the amount of radiation arriving at the receiver. By using the intensities measured at the receivers the automatic control circuit attempts to adjust the transmitter power in such a way that the dynamic range, which is determined by **DYN WIN LO** and **DYN WIN HI**, is not exceeded.

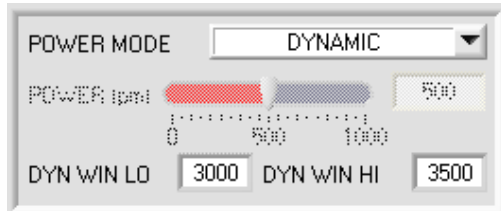

**AVERAGE:**

This function field is used for setting the number of scan values (measurement values) over which the raw signal measured at the receiver is averaged. A higher **AVERAGE** default value reduces the noise of the **RAW** signal. At the same time it also reduces the maximum achievable switching frequency of the sensor.

**OUTMODE:**

This group of function buttons is used to determine the operating mode of digital output **OUT0** when the tolerance threshold is exceeded.

**DIRECT:** in case of error  $OUT0 = 0VDC$  (low-active)

**INVERSE:** in case of error  $OUT0 = +24VDC$  (high-active)

On the user interface the respective status of the **OUT0** output is visualised by way of the **OUT** LED.

**HOLD:**

The electronic control unit operates with minimum scan times in the range of less than 100µs. For this reason most of the PLCs that are connected at the digital error output **DIGITAL OUT** have difficulties with the reliable detection of the resulting short changes of switching states. Entering a suitable value in the **HOLD** edit box sets a pulse lengthening of up to 100 ms at the digital output of the electronic control unit.

**TEMP COMP:** With **TEMP COMP** the internal temperature compensation can be switched on or off

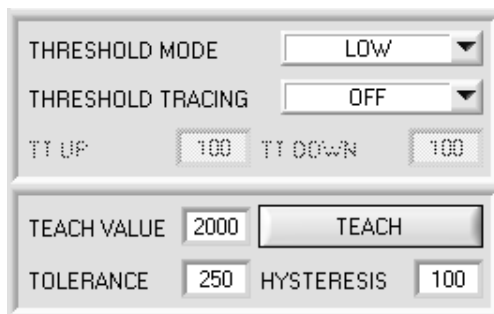

**THRESHOLD MODE:**

In this function field one of three possible positions of the switching threshold and hysteresis threshold with respect to the reference value **REF** can be selected.

If **THRESHOLD TRACING** is set to **OFF** (deactivated), the **TEACH VALUE** is identical with the reference value **REF**.

Pressing the **TEACH** button "teaches" the current **RAW** measurement value as **TEACH VALUE**.

Pressing the **SEND** button sends the **TEACH VALUE** (reference) to the electronic control unit.

Based on **REF** the switching threshold and the hysteresis threshold are calculated differently with **THRESHOLD MODE LOW, HI** and **WIN**.

The different lines in the graphic windows below have the following meaning:

Green line = current measurement value

Blue dotted line = reference value

Red line = switching threshold

Black dashed line = hysteresis threshold



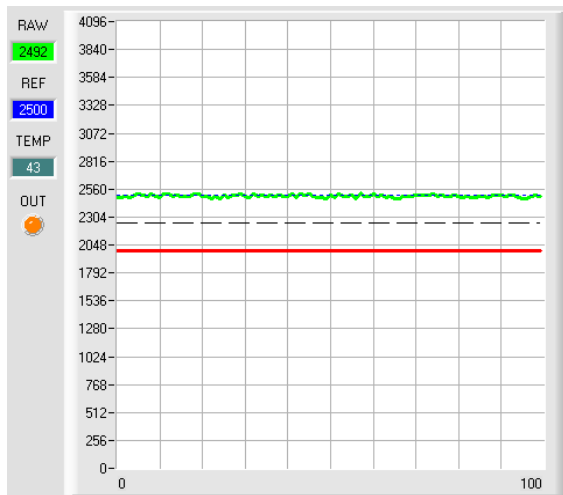

**THRESHOLD MODE LOW:**

Switching threshold = **REF - TOLERANCE**

Hysteresis threshold = switching threshold + **HYSTERESIS**

When the current measurement value **RAW** falls below the switching threshold, the digital output **DIGITAL OUT** is set to error.

When the current measurement value rises above the hysteresis threshold again, the error output is reset again.

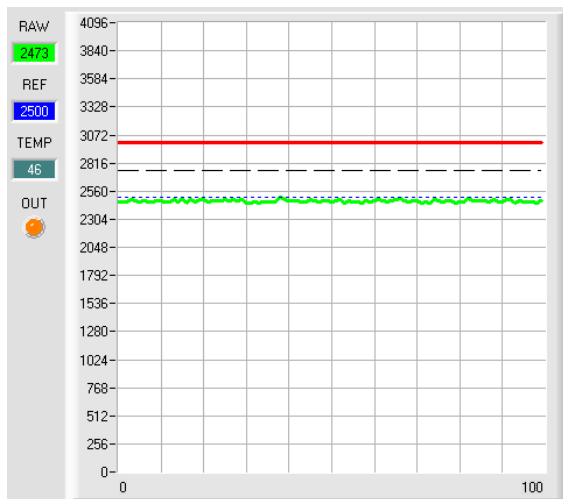

**THRESHOLD MODE HI:**

Switching threshold = **REF + TOLERANCE**

Hysteresis line = switching threshold - **HYSTERESIS**

When the current measurement value **RAW** rises above the switching threshold, the digital output **DIGITAL OUT** is set to error.

When the current measurement value falls below the hysteresis threshold again, the error output is reset again.

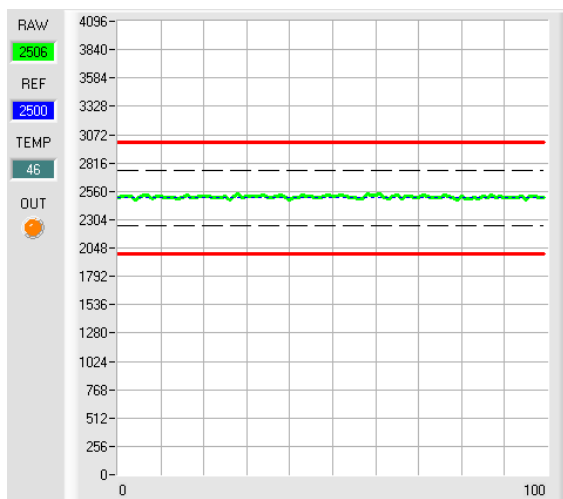

**THRESHOLD MODE WIN:**

Upper switching threshold = **REF + TOLERANCE**

Upper hysteresis threshold = upper switching threshold - **HYSTERESIS**

Lower switching threshold = **REF - TOLERANCE**

Lower hysteresis threshold = lower switching threshold + **HYSTERESIS**

The switching thresholds form a symmetrical tolerance band around the current reference value. When the current measurement value **RAW** leaves this tolerance band, the digital output **DIGITAL OUT** is set to error.

The error output is reset again when the current measurement value lies below/above the hysteresis threshold again.

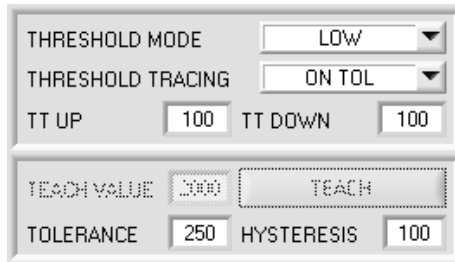

**THRESHOLD TRACING:**

With this function field automatic tracing of the switching threshold can be turned on or off.

**OFF:** Automatic threshold tracing is deactivated.

**EXT:** The reference value **REF** is applied to the current **RAW** value with a positive edge at input IN0. Based on the new reference, the switching threshold and the hysteresis threshold are calculated anew depending on the **THRESHOLD MODE**. The sensor only continues to operate as usual when IN0 falls again.

**ATTENTION!** The reference value **REF** is lost after a system reset and must be learned again with a positive edge at IN0.

**ON TOL and ON CONT:** Automatic threshold tracing is activated. The current reference value is cyclically checked. If the current reference value decreases, for example due to increasing dirt accumulation, the set switching thresholds will be correspondingly adapted.

If **ON TOL** is chosen, threshold correction is only active when the current signal lies within the tolerance.

If **ON CONT** is chosen, threshold correction is always active.

**TT UP and TT DOWN:**

In this function field a time constant for the speed of automatic threshold tracing can be set. The current reference value is cyclically checked by the  $\mu$ C-software. The numeric value that is set here defines the time interval between two such reference value checks.

**TT UP (THRESHOLD TRACING UP):** If the current reference value increases, the current switching threshold will be adapted with the set time delay.

**TT DOWN (THRESHOLD TRACING DOWN):** If the current reference value decreases, the current switching threshold will be adapted with the set time delay.

Value range: 0 ... 60000

One step means a time delay of 10 micro-seconds. However, tracing cannot be faster than the scan frequency that is achievable with **AVERAGE**.

Value = 0: Minimum time delay, fastest tracing.

Value = 60000: Maximum time delay, slowest tracing.

The calculation of the switching thresholds depends on the **THRESHOLD MODE** (see **THRESHOLD MODE**).

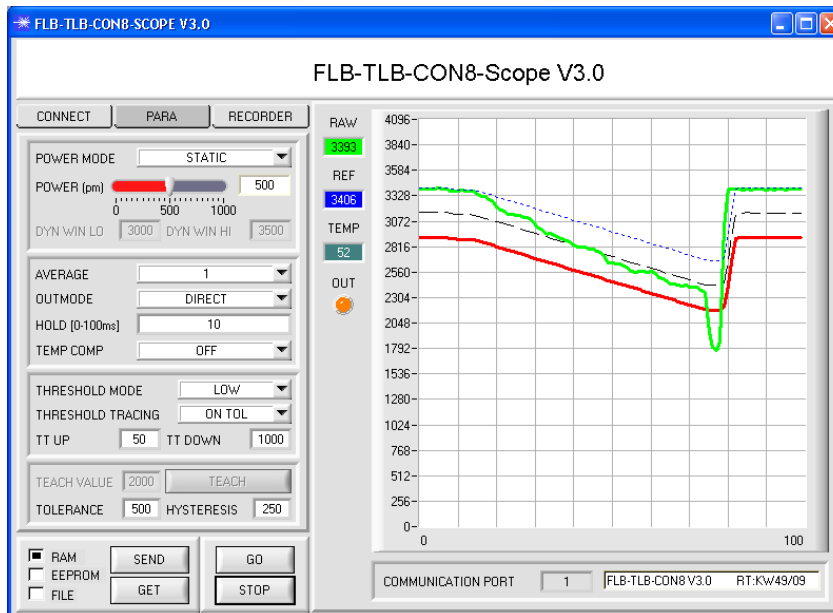

In the example a value of 1000 was entered for **TT DOWN**.

This means that downward threshold tracing is performed at a relatively slow speed.

In the chart this can be clearly seen in the blue reference line.

The measurement value **RAW** (green line) drops relatively fast, compared to this the reference value **REF** follows much slower.

This is a typical case that occurs when increasing dirtying of the sensor must be compensated.

If **ON TOL** is chosen, threshold tracing is stopped when the current measurement value falls below the switching threshold. When **RAW** rises above the hysteresis threshold again, threshold tracing will become active again. In the example upward threshold tracing is performed at a high speed, because a small value was entered for **TT UP**.

## 2.3 Tab RECORDER

The FLB-TLB-CON8-Scope software features a data recorder that allows the saving of RAW and TEMP. The recorded file is saved to the hard disk of the PC and can then be evaluated with a spreadsheet program.

The file that is created has eight columns and as many rows as data frames were recorded. A row is structured as follows: Date, Time, **RAW**, **TEMP**.

The following steps describe how data frames are recorded with the recorder:

### Step 1:

When the **RECORDER** button is pressed, the following window will be displayed:

When the **SHOW GRAPH** button is pressed, a panel will be displayed that allows the user to monitor the different signals.

The individual signals can be activated from the **SIGNAL** drop-down menu.

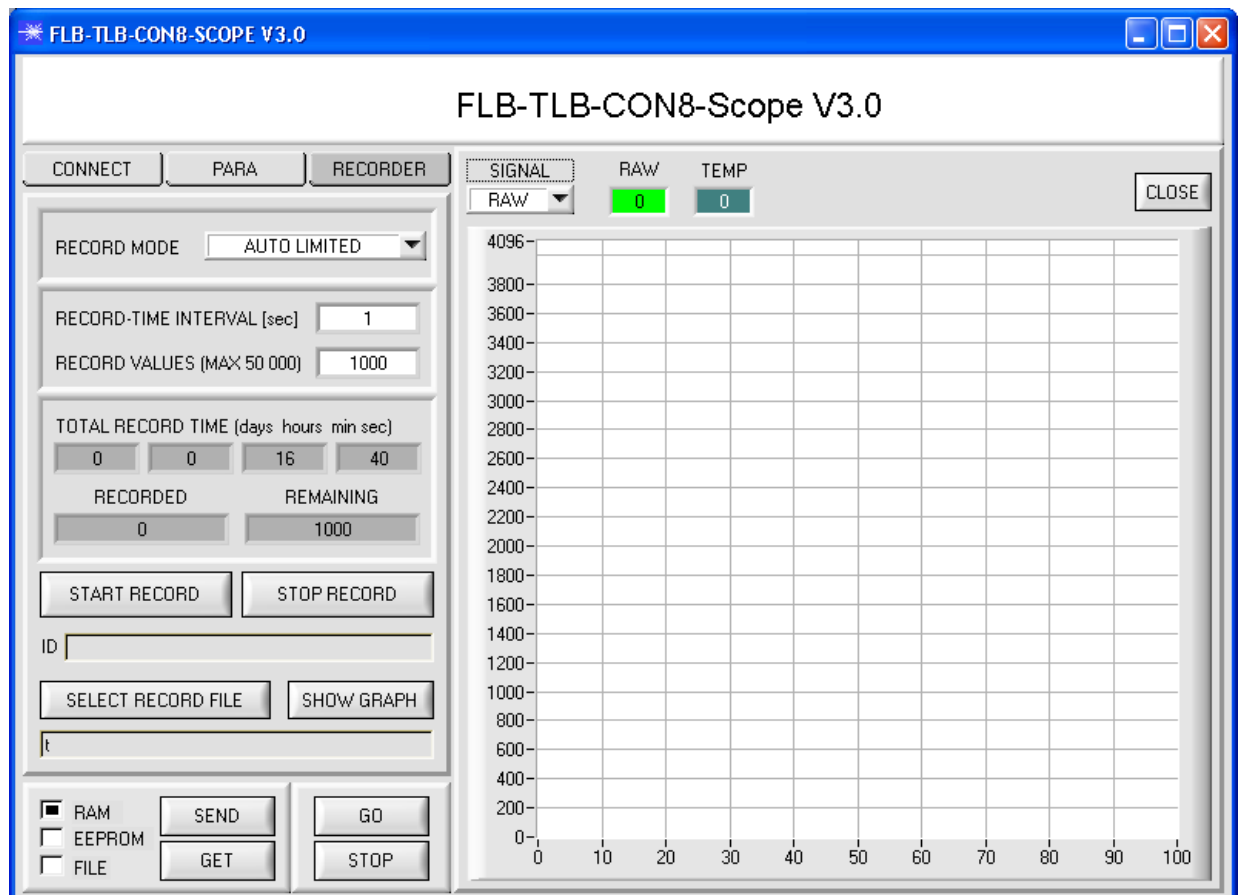

**Step 2:**

If you want to automatically record several data frames, please select **AUTO LIMITED** under **RECORD MORE**. Enter a time interval for recording under **RECORD-TIME INTERVAL [sec]**, in this example: 1, i.e. a new value is called from the sensor every second). Then enter the maximum number of values you wish to record in the **RECORD VALUES [MAX 50 000]** field. Please note: Recording can also be stopped earlier by clicking **STOP RECORD**, the data recorded so far will not be lost.

The **TOTAL RECORD TIME** field indicates how long recording will take (in days, hours, minutes, and seconds) if all data are recorded.

**Step 3:**

By pressing the button **SELECT RECORD FILE** a file can be selected in which the data frame will be stored. If you select an already existing file name, you will be asked whether you want to overwrite the existing file or not.

**Step 4:**

Pressing the **START RECORD** button starts automatic data recording.

The recorder starts to record data, and the button **START RECORD** is red to indicate that recording is active. The respective data frames are shown in the display windows. In the two display fields **RECORDED** and **REMAINING** you can check how many data frames have been recorded, and how many frames remain to be recorded.

**Please note:**

**During recording the two input fields RECORD-TIME INTERVAL and VALUES TO BE RECORDED are inactive.**

**Step 5:**

When as many data frames as set under **RECORD VALUES [MAX 50 000]** have been recorded, or when the **STOP AUTO RECORD** button is pressed, a pop-up window will appear which confirms that the file is stored.

If you want to record an unlimited number of data, select the **AUTO UNLIMITED** function under **RECORD MORE**. Then select the desired recording interval and press **START RECORD**.

If you want to record data "manually", select the **MANUAL RECORDING** function under **RECORD MORE**. You can start reading data from the sensor by pressing the **GO** button. These data are visualised in the display window. Pressing the **CAPTURE DATA FRAME** button saves a data frame in the file that was selected under **SELECT RECORD FILE**. The **RECORDED** field shows the sum of the frames already recorded.

**Please note:**

**When a file is selected with SELECT RECORD FILE, this file will be newly created. Then a file header with information about the meaning of the individual columns in the file will be saved. When data are recorded, these will be added to the selected file, even if data recording is stopped and then resumed again.**

## 2.4 Graphic display elements

Various displays and a graphic window are available for visualising all the data that are important for parameterisation. The individual displays and the graph are explained below.



**RAW:**  
This display shows the current measurement value.  
In the graph this value is visualised as a green line.



**REF:**  
This display shows the current reference value. This value is the basis for calculating the switching thresholds. When **THRESHOLD TRACING** is set to **OFF**, the **TEACH VALUE** also is the reference value. When **THRESHOLD TRACING** is set to **ON**, the reference value is calculated by the electronic control unit. The switching thresholds are then traced to the value calculated in the sensor.  
The reference value **REF** is shown as a blue line in the graph.

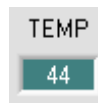

**TEMP:**  
This display shows the temperature in the sensor housing.  
The display **DOES NOT** show degrees Celsius or Fahrenheit.



**OUT:**  
This LED visualises the physical state of output **DIGITAL OUT**.  
When the LED is black, **DIGITAL OUT** is at 0V.  
When the LED is orange, **DIGITAL OUT** is at +24V

The settings in the graph below are **THRESHOLD MODE=LOW**, **THRESHOLD TRACING=OFF**, **TEACH VALUE=2500**, **TOLERANCE=500**, and **HYSTERESIS=150**.

This results in a switching threshold of **TEACH VALUE 2500** minus **TOLERANCE 500** = 2000 (red line) and a hysteresis threshold of switching threshold 2000 plus **HYSTERESIS 150** = 2150 (black line).

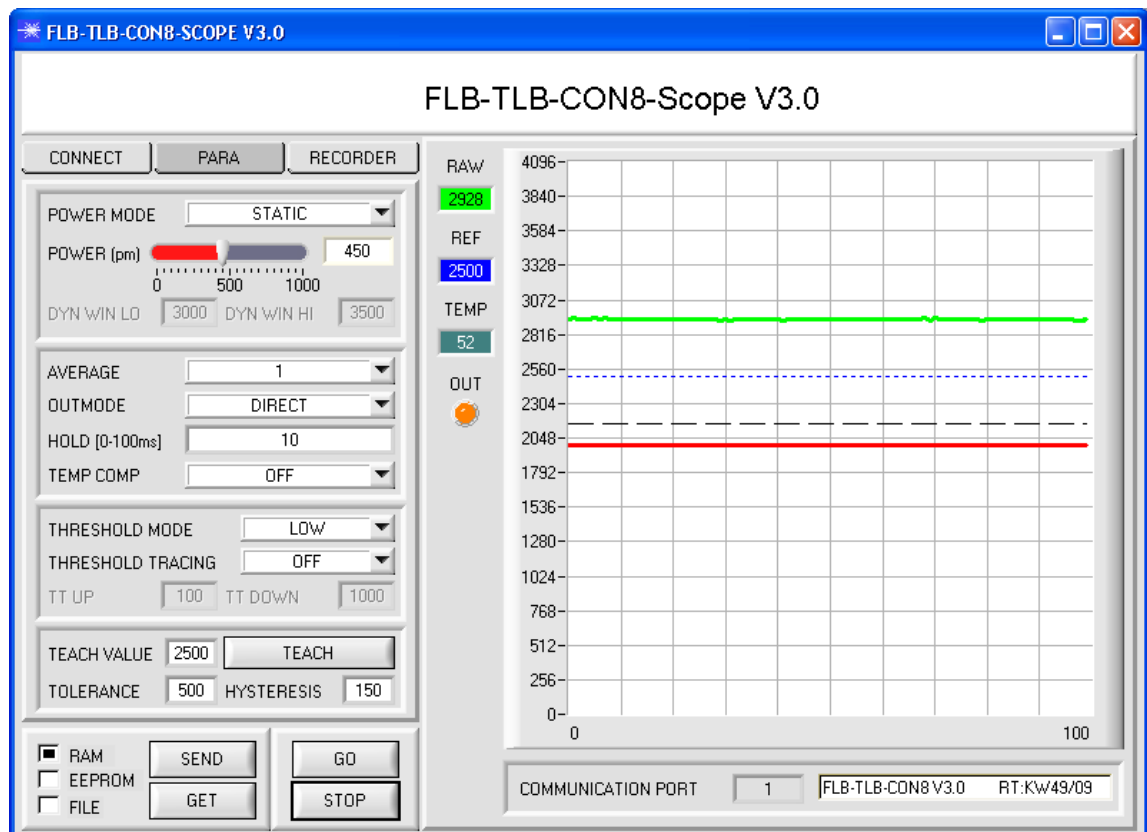

### 3. Short instructions for the operation of FLB or TLB sensor systems with the FLB-TLB-CON8-Scope V3.0 software

These instructions will allow you to swiftly parameterise sensor systems of the FLB or TLB series by using the FLB-TLB-CON8-Scope V3.0 software interface.

Basically there are three methods of monitoring a switching threshold. The desired method can be set with the **THRESHOLD MODE** software parameter.

#### **THRESHOLD MODE LOW:**

In this mode the **switching threshold** lies under the current reference value. The distance of the switching threshold from the reference value **REF** is defined by the **TOLERANCE** setting value. In this operating mode the **HYSTERESIS THRESHOLD** lies above the switching threshold. When automatic threshold tracing is active (**THRESHOLD TRACING=ON**), suitable time constants must be chosen for threshold tracing.

#### **THRESHOLD MODE HI:**

In this mode the **switching threshold** lies above the current reference value. The distance of the switching threshold from the reference value **REF** is defined by the **TOLERANCE** setting value. In this operating mode the **HYSTERESIS THRESHOLD** lies under the switching threshold. When automatic threshold tracing is active (**THRESHOLD TRACING=ON**), suitable time constants must be chosen for threshold tracing.

#### **THRESHOLD MODE WIN:**

This mode operates with two **switching thresholds** that lie symmetrically around the current reference value **REF**. The distance of the switching thresholds from the reference value **REF** is defined by the **TOLERANCE** setting value. In this operating mode the two **HYSTERESIS THRESHOLDS** lie within the tolerance band. When automatic threshold tracing is active (**THRESHOLD TRACING=ON**), suitable time constants must be chosen for threshold tracing.

In the example below the sensor system is parameterised with the following settings: **THRESHOLD MODE=LOW, OUTMODE=DIRECT, POWER MODE=STATIC, and THRESHOLD TRACING=OFF.**

**Step 1:**

Prior to the use of the software aids (graphic display of sensor signals) the sensor must be manually adjusted as accurately as possible. Dieser Vorgang ist dem Datenblatt des jeweiligen Sensortyps zu entnehmen.

Please make sure that the sensor is properly connected and supplied with power.

**Step 2:**

Start the FLB-TLB-CON8-Scope V3.0 software. Please check whether the status line at the right bottom displays the „FLB-TLB-CON8 V3.0 RT:KWxx/xx “ message.

**Info:** Moving the mouse cursor to a control element and clicking with the right mouse button displays a short info on the respective individual control element.

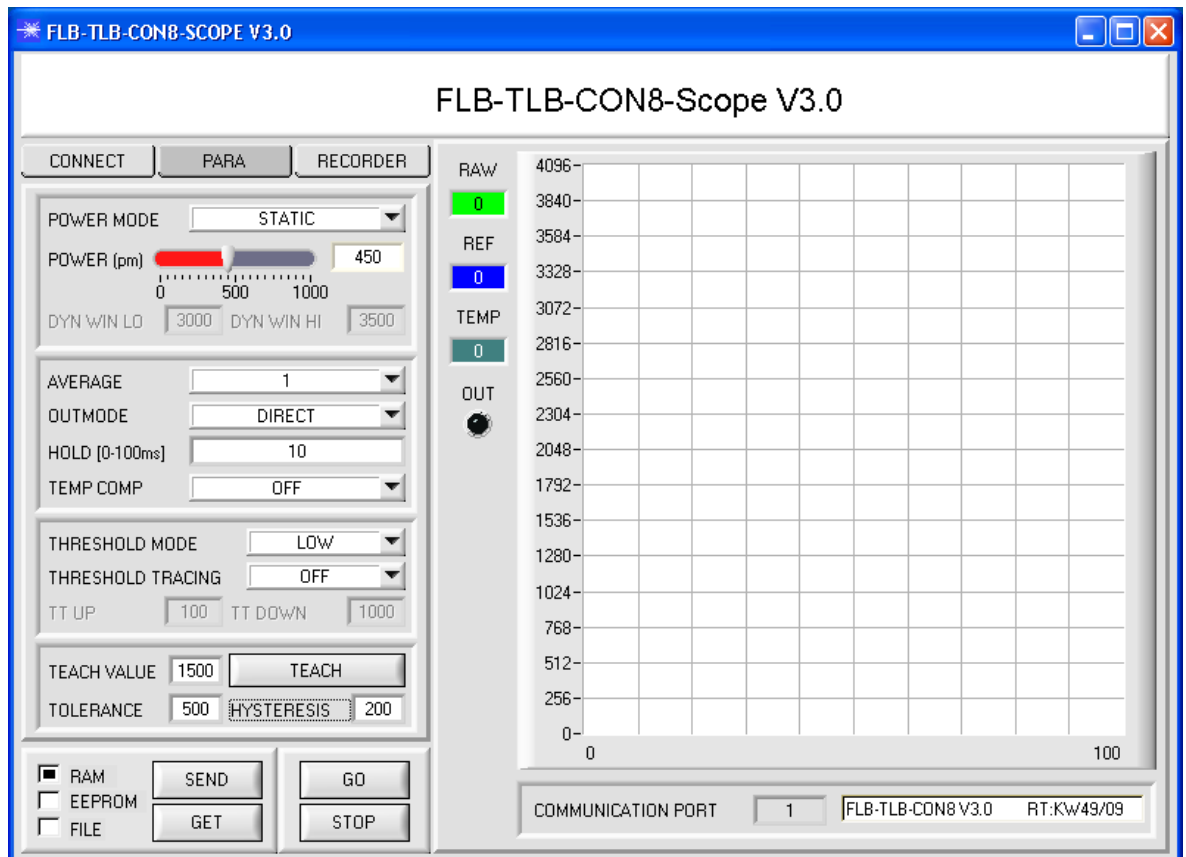

**Step 3:**

Please make sure that for the time being **RAM** and not **EEPROM** is selected for the data exchange with the sensor (**RAM** is a volatile memory in the sensor, i.e. the data will be lost when power is turned off. EEPROM is a non-volatile memory in the sensor, i.e. the data will not be lost when power is turned off.)

All the other parameters should be set as shown in the picture below. Press the tab **PARA** to show the parameters. (See the **FILE** function at page 6.)

Now press the **GO** button. Data exchange between sensor and PC will then start. On the software interface the measurement value **RAW** that is measured by the electronic control unit is shown in a display and as a green line in the graph. Set the **POWER** value such that **RAW** lies in the upper third of its dynamic range.

**ATTENTION:** The sensor must be informed when you have changed the **POWER** value. Press the **SEND** button to send this information to the sensor. Check **RAW** by pressing **GO** again. Repeat this process until you have a suitable **POWER** value.

**Tip!** There is a trick for finding a suitable **POWER** value in no time at all. Set **POWER MODE = DYNAMIC**. The sensor then tries to find a suitable **POWER** value. Check this by pressing **GO**. Press **STOP** when the bars have "levelled out". Then press **GET**. The **POWER** value that was found now is shown in the **POWER** function field. Now set **POWER MODE = STATIC**, and press **SEND**.

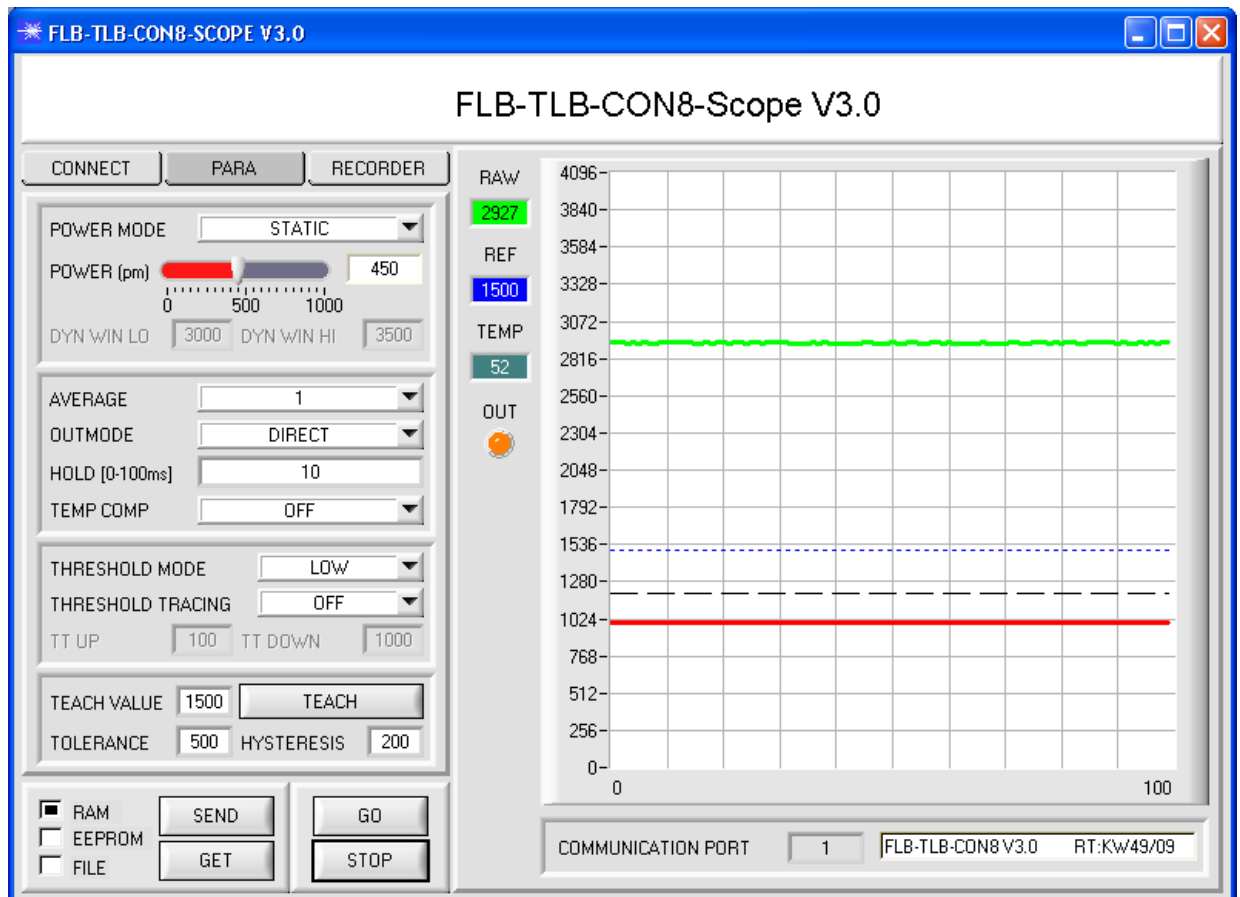



**Step 4:**

Press the **GO** button.

Now press the **TEACH** button. The current **RAW** value is written to the **TEACH VALUE** edit box. When the **SEND** button is pressed, the **TEACH VALUE** is updated as the reference **REF** in the sensor.

**Info:** With **THRESHOLD TRACING=ON** or **EXT**, the control unit calculates the reference **REF** automatically or with **EXT** takes the REF value from the **RAW** value after a positive edge at IN0. This means that **TEACH VALUE** and **TEACH** are not active with **THRESHOLD TRACING=ON** or **EXT**.

The reference value **REF** (blue line) is used for calculating the switching threshold (red line) and the hysteresis threshold (black line).

Switching threshold = **REF – TOLERANCE** = red line

hysteresis threshold = switching threshold + **HYSTERESIS** = black line

The **TOLERANCE** value must be chosen such that the switching threshold always and reliably is exceeded when a faulty object is measured.

Accept parts should lie in the range between the reference value **REF** and the switching threshold. The value of **TOLERANCE** is determined, for example, by the production-related variance of accept parts.

The hysteresis threshold prevents digital output activation in cases when the measurement value falls below the switching threshold only for a short time.

Press the **GO** button again.

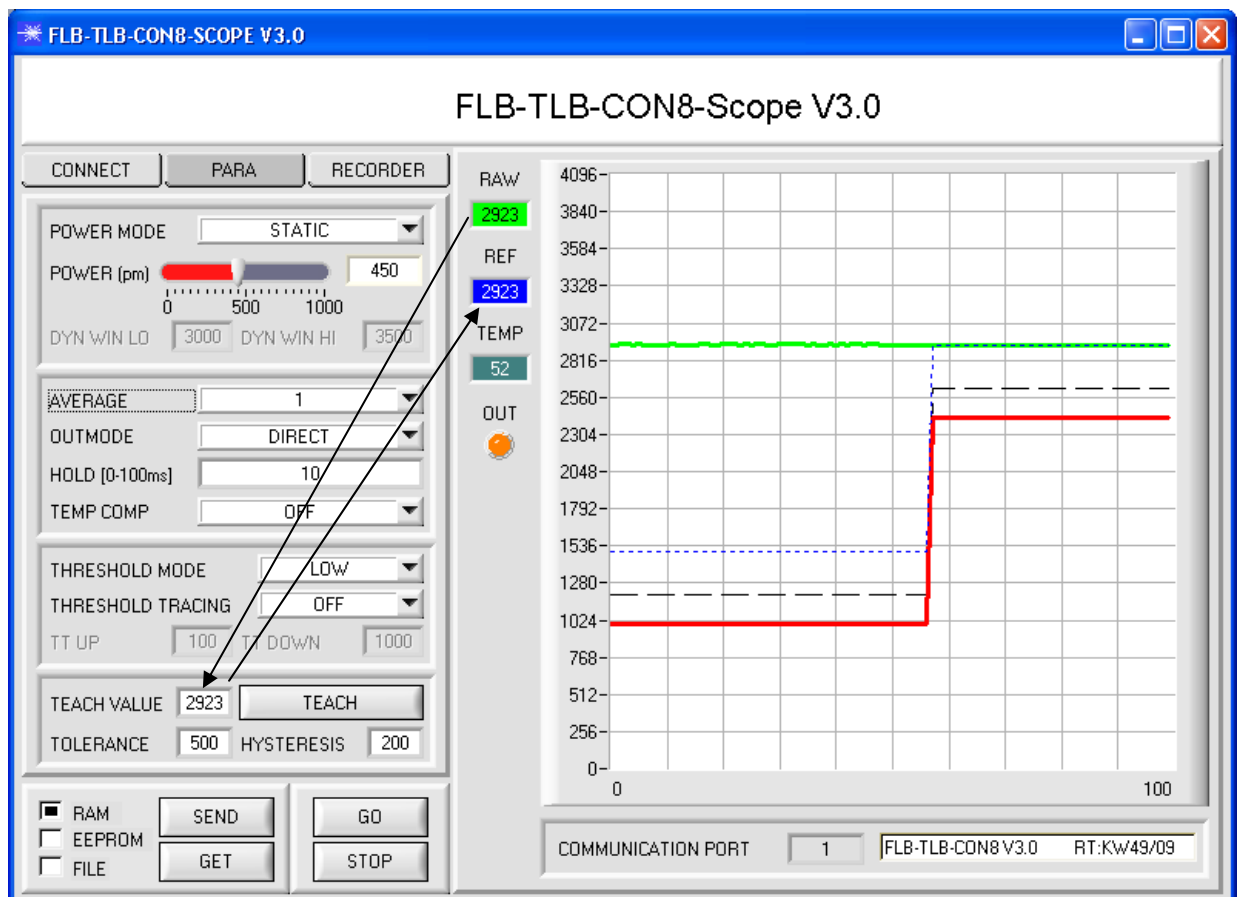

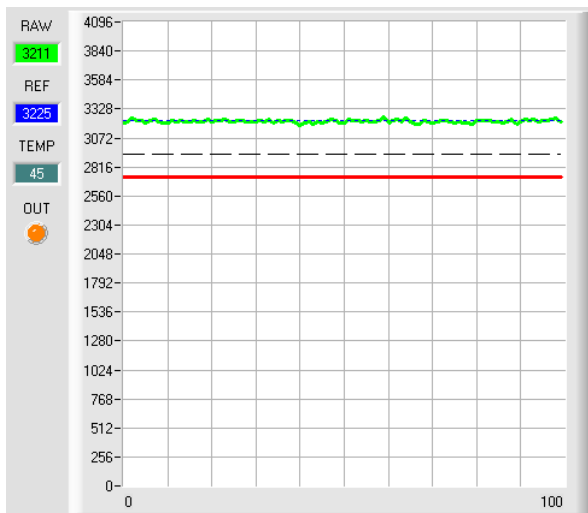

As long as the current measurement value **RAW** (green line) lies above the switching threshold (red line), the output **OUT0** is at +24V (signal is OK). This is visualised by the **OUT** LED.

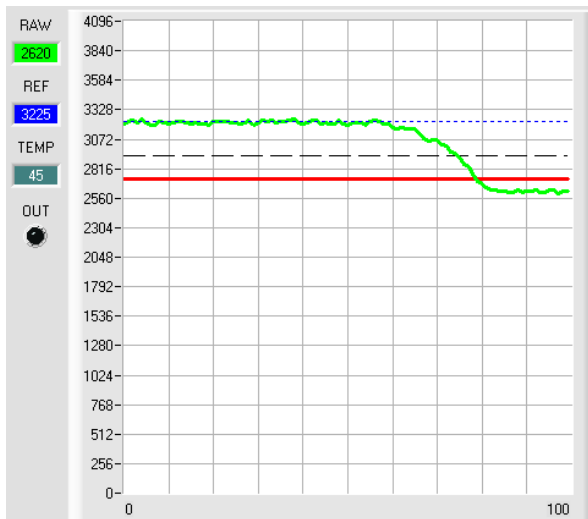

When the current measurement value **RAW** (green line) falls below the switching threshold (red line), the output **OUT0** changes to 0V (error). This is visualised by the **OUT** LED.

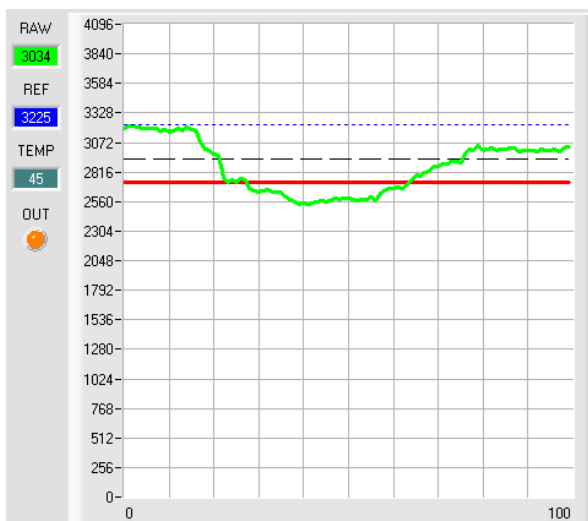

When the current measurement value **RAW** (green line) rises above the hysteresis threshold (black line) again, the output **OUT0** changes to +24V again (signal is OK). This is visualised by the **OUT** LED.

**Step 5:**

When parameterisation is finished, please select **EEPROM** and press **SEND** to save the data to the non-volatile memory of the sensor.

## 4. Operation of the TEMPCOMP-Scope software

If a firmware update should go wrong and the temperature characteristics that are stored in the EEPROM should be lost, these characteristics must be created anew. For this purpose you will need a file with the corresponding data. This file can be obtained from your supplier.

To perform temperature compensation please start the corresponding TEMPCOMP-Scope software that is included on the supplied CD. Please make sure that you have a functioning sensor connection. It may be necessary to select the connection with **CONNECT**. Set the correct sensor under **SELECT SENSOR**, if this is not done automatically.

- Step 1: Load the temperature compensation file that you have received from your supplier with **GET EQUATION FROM DISK**.
- Step 2: Press **CALCULATE CURVES** to display the data in the graph.
- Step 3: Select the sensor-internal operating temperature (not in °C) that the sensor has at an ambient temperature of 20°. The value should be included in the file designation.
- Step 4: Press **CALCULATE CALIBRATION CURVES** to calculate the mean straight line.
- Step 5: Pressing the **SEND CF** button saves the mean straight lines in the EEPROM of the sensor.
- Step 6: Temperature compensation is successfully finished if the **SUCCESS** status message is then displayed.

**Comment!** If you do not immediately have the temperature compensation file at hand, simply start the **TempComp-Scope software**. Establish a connection, if it is not already established, and simply press **SEND-CF**. The sensor then functions as before, but it is not temperature-compensated.

## 5. Connector assignment of the FLB-CON8 or TLB-CON8-FIO-IR electronic control unit

**Connection of electronic control unit FLB-CON8 or TLB-CON8-FIO-IR to PC:**

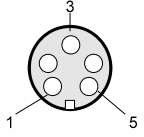
<b>5-pole fem. connector (type Binder 712) FLB-CON8 or TLB-CON8-FIO-IR / PC-RS232</b>  <b>Connecting cable: cab-las5/PC-(length)</b>		 
Pin-No.:		Assignment:
1		0V (GND)
2		Tx0
3		Rx0
4		+24VDC (+Ub, OUT)
5		Not connected

**Connection of electronic control unit FLB-CON8 or TLB-CON8-FIO-IR to PLC:**

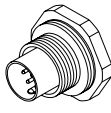
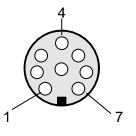
<b>8-pole connector (type Binder 712) FLB-CON8 or TLB-CON8-FIO-IR / PLC</b>  <b>Connecting cable: cab-las8/SPS-fem-(length)</b>		 
Pin-No.:	Color of wire: (cab-las8/SPS-fem)	Assignment:
1	white	0V (GND)
2	brown	+24V ( $\pm 10\%$ )
3	green	IN0
4	yellow	OUT0 (Digital 0: typ. 0 ... 1V, Digital 1: typ. +Ub – 10%)
5	grey	Not connected
6	pink	ANALOG (0V ... +10V)
7	blue	Not connected
8	red	Not connected

## 6. Scan frequencies at different settings

Scan frequencies in Hz (worst case) in case of **POWER MODE = STATIC, THRESHOLD TRACING = OFF, TEMP-COMP = OFF** and different **AVERAGE** settings.

AVERAGE	1	2	4	8	16	32	64	128
Scan frequency	200000	127000	77800	43850	23400	12100	6175	3100

AVERAGE	256	512	1024	2048	4096	8192	16384	32768
Scan frequency	1560	780	390	195	98	49	25	12,5

Scan frequencies in Hz (worst case) in case of **POWER MODE = DYNAMIC, THRESHOLD TRACING = OFF, TEMP COMP = OFF** as well as in case of **POWER MODE = STATIC, THRESHOLD TRACING = ON, TEMP COMP = OFF** and different **AVERAGE** settings.

AVERAGE	1	2	4	8	16	32	64	128
Scan frequency	160750	109200	70800	41500	22800	12000	6125	3100

AVERAGE	256	512	1024	2048	4096	8192	16384	32768
Scan frequency	1562	781	390	195	98	49	24	12

Scan frequencies in Hz (worst case) in case of **POWER MODE = DYNAMIC, THRESHOLD TRACING = ON, TEMP COMP = OFF** and different **AVERAGE** settings.

AVERAGE	1	2	4	8	16	32	64	128
Scan frequency	142500	100500	67000	40000	22300	11800	6100	3100

AVERAGE	256	512	1024	2048	4096	8192	16384	32768
Scan frequency	1550	785	392	196	98	49	24,5	12

## 7. RS232 communication protocol

<b>RS232 communication protocol PC ↔ FLB-CON8 or TLB-CON8-FIO-IR electronic control unit (FLB-TLB-CON8-Scope V3.0)</b>
<p>- Standard RS232 serial interface without hardware-handshake                      - 3-wire: GND, TX0, RX0                      - Speed: 19200 baud factory setting, can be changed (example 190) to 9600, 19200, 38400, 57600, 115200                      8 data-bits, no parity-bit, 1 stop-bit in binary mode, us (unsigned), MSB (most significant byte) first.</p> <p>The control device (PC or PLC) has to send a data frame of 18 words to the Sensor. All bytes must be transmitted in binary format (us, MSB). The meaning of the parameters is described in the software manual.                      Info: 1 word = 2 bytes  <u>Method:</u>                      The hardware is permanently reading (polling) the incoming byte at the RS232 connection. If the incoming word is 0x0055 (synch-word), then the 2. word (order-word) is read in, after this, 16 words (parameters) will be read. After reading in the completely data frame, the Sensor executes the order which is coded at the 2. word (order-word).</p>

<b>Format of the data frame:</b>			
Word No.	Format	Meaning	Comment:
1	Word	sync-word = 0x0055	hex-code 0x0055, binary: 0000 0000 0101 0101, synchronisation word
2	Word	ORDER NUMBER	order word
3	Word	Para POWER	LED intensity (0 ... 1000) Attention intensity in thousandth!
4	Word	Para POWER MODE	LED mode: STATIC, DYNAMIC coded to (0, 1)
5	Word	Para DYN WIN LO	Low limit for dynamic window when POWERMODE=dynamic (0...4095)
6	Word	Para DYN WIN HI	High limit for dynamic window when POWERMODE=dynamic (0...4095)
7	Word	Para AVERAGE	Signal averaging 1, 2, 4, 8, 16, 32, 64, 128, 256, 512, 1024, 2048, 4096, 8192, 16384 or 32768
8	Word	Para OUTMODE	Function of the digital output: direct, inverse coded to (0,1)
9	Word	Para HOLD	Hold time for minimum pulse length coded to (0...100) [ms]
10	Word	Para THRESHOLD MODE	Select Threshold Mode LOW, HI, WIN coded to (0,1,2)
11	Word	Para THRESHOLD TRACING	Select Threshold Tracing OFF, ON or EXT coded to (0,1,2)
12	Word	Para TT UP	Time delay for Threshold Tracing Up (0...60000)
13	Word	Para TT DOWN	Time delay for Threshold Tracing Down (0...60000)
14	Word	Para TEACH VALUE	Teach Value (Reference) for threshold calculation (0...4095)
15	Word	Para TOLERANCE	Tolerance Value for threshold calculation (0...4095)
16	Word	Para HYSTERESIS	Hysteresis for threshold calculation (0...4095)
17	Word	Para TEMP COMP	Enable or disable temperature compensation (0, 1)
18	Word	Free	Must be send as dummy

Value	ORDER NUMBER	(parameter byte no. 2)
0	nop	no operation
1	Save parameter from PC into RAM	Cf. Example 1
2	Free	
3	Send parameter from RAM to PC	Cf. Example 3
4	Free	
5	Send data from RAM to PC	Cf. Example 5
6	Save parameter from RAM to EEPROM	Cf. Example 6
7	Send connection OK to PC	Cf. Example 7
8	Load Parameter from EEPROM to RAM	Cf. Example 8
20	Send line ok = 0x00AA, 0x0014, 0x00AA, 15 Dummies to PC	Cf. Example 20
190	Change baud rate	CF.Example190

**Example 1: DATA FRAME with ORDER NUMBER = 1:**

ORDER NUMBER (second word = 1): WRITE parameters from PC into RAM of the sensor!

The completely data frame = 18 words must be sent to the sensor hardware in binary form (sync-word / order-word / 16 parameter words).

DATA FRAME PC → Sensor (18 WORDS)

0x0055	SYNC.-WORD
1	ORDER-WORD
200	POWER
0	POWER MODE
3000	DYN WIN LO
3500	DYN WIN HI
1	AVERAGE
0	OUTMODE
10	HOLD
0	THRESHOLD MODE
0	THRESHOLD TRACING
100	TT UP
100	TT DOWN
2000	TEACH VALUE
250	TOLERANCE
100	HYSTERESIS
0	TEMP COMP
0	DUMMY

DATA FRAME Sensor → PC (18 WORDS)

0x00AA	SYNC.-WORD
1	ORDER-WORD
200	POWER
0	POWER MODE
3000	DYN WIN LO
3500	DYN WIN HI
1	AVERAGE
0	OUTMODE
10	HOLD
0	THRESHOLD MODE
0	THRESHOLD TRACING
100	TT UP
100	TT DOWN
2000	TEACH VALUE
250	TOLERANCE
100	HYSTERESIS
0	TEMP COMP
0	DUMMY

**Example 3: DATA FRAME with ORDER NUMBER = 3:**

ORDER NUMBER (second word = 3): READ parameters out of sensor-RAM memory!

The same frame as example 1 must be sent to the sensor except of the order word that must be 3. The values for the parameters must be sent as Dummies.

The complete DATA FRAME which is responded by the sensor is 18 words.

DATA FRAME PC → Sensor (18 WORDS)

0x0055	SYNC.-WORD
3	ORDER-WORD
0	DUMMY
0	DUMMY
0	DUMMY
0	DUMMY
0	DUMMY
0	DUMMY
0	DUMMY
0	DUMMY
0	DUMMY
0	DUMMY
0	DUMMY
0	DUMMY
0	DUMMY
0	DUMMY
0	DUMMY
0	DUMMY

DATA FRAME Sensor → PC (18 WORDS)

0x00AA	SYNC-WORD
3	ORDER-WORD
200	POWER
0	POWER MODE
3000	DYN WIN LO
3500	DYN WIN HI
1	AVERAGE
0	OUTMODE
10	HOLD
0	THRESHOLD MODE
0	THRESHOLD TRACING
100	TT UP
100	TT DOWN
2000	TEACH VALUE
250	TOLERANCE
100	HYSTERESIS
0	TEMP COMP
0	DUMMY



**Example 5: DATA FRAME with ORDER NUMBER = 5:**

ORDER NUMBER (second word = 5): READ DATA

Parameters must be sent for a constant parameter frame as dummies.

At order word 5 they do not affect the RAM or EEPROM.

DATA FRAME PC → Sensor (18 WORDS)

0x0055	SYNC.-WORD
5	ORDER-WORD
0	DUMMY
0	DUMMY
0	DUMMY
0	DUMMY
0	DUMMY
0	DUMMY
0	DUMMY
0	DUMMY
0	DUMMY
0	DUMMY
0	DUMMY
0	DUMMY
0	DUMMY
0	DUMMY
0	DUMMY
0	DUMMY

DATA FRAME Sensor → PC (18 WORDS)

0x00AA
5
RAW
LED OUT
REF
DUMMY
DUMMY
DUMMY
DUMMY
DUMMY
DUMMY
DUMMY
DUMMY
DUMMY
DUMMY
DUMMY
DUMMY
DUMMY
TEMP

**Example 6: DATA FRAME with ORDER NUMBER = 6:**

ORDER NUMBER (second word = 6): SAVE parameters from RAM to EEPROM of the sensor!

The complete data frame = 18 words must be sent to the sensor in binary form

(sync-word / order-word / 16 parameter words).

DATA FRAME PC → Sensor (18 WORDS)

0x0055	SYNC.-WORD
6	ORDER-WORD
0	DUMMY
0	DUMMY
0	DUMMY
0	DUMMY
0	DUMMY
0	DUMMY
0	DUMMY
0	DUMMY
0	DUMMY
0	DUMMY
0	DUMMY
0	DUMMY
0	DUMMY
0	DUMMY
0	DUMMY
0	DUMMY
0	DUMMY

After sending this data frame, the sensor saves all the parameters from its RAM (volatile memory) to its EEPROM (non volatile memory).

ATTENTION: The right parameters must be in the RAM of the sensor. See Example 1 to save the parameters into the RAM.

After completing the sensor writes back an echo of the same frame.

DATA FRAME Sensor → PC (18 WORDS)

0x00AA	SYNC-WORD
6	ORDER-WORD
0	DUMMY
0	DUMMY
0	DUMMY
0	DUMMY
0	DUMMY
0	DUMMY
0	DUMMY
0	DUMMY
0	DUMMY
0	DUMMY
0	DUMMY
0	DUMMY
0	DUMMY
0	DUMMY
0	DUMMY
0	DUMMY
0	DUMMY

**Example 7: DATA FRAME with ORDER NUMBER = 7**

ORDER NUMBER (second word = 7): SEND CONNECTION OK from the Sensor! Cf. example 1:

Send the same DATA FRAME but with ORDER NUMBER 7 to the sensor.

The sensor will reply with 18 words which tell the version of the sensor.

**Example 8: DATA FRAME with ORDER NUMBER = 8**

ORDER NUMBER (second word = 8): Load parameters from EEPROM to RAM of the sensor!  
The complete data frame = 18 words must be sent to the sensor in binary form (sync-word / order-word / 16 parameter words).

DATA FRAME PC → Sensor (18 WORDS)

0x0055	SYNC.-WORD
8	ORDER-WORD
0	DUMMY
0	DUMMY
0	DUMMY
0	DUMMY
0	DUMMY
0	DUMMY
0	DUMMY
0	DUMMY
0	DUMMY
0	DUMMY
0	DUMMY
0	DUMMY
0	DUMMY
0	DUMMY
0	DUMMY
0	DUMMY

After sending this data frame, the sensor loads all the parameters from it's EEPROM (non volatile memory) to it's RAM (volatile memory).  
ATTENTION: The EEPROM parameters must be load first to the RAM to read it from the sensor.  
See 'Example 3' to get the parameters from the RAM.  
After completing the sensor writes back an echo of the same frame.

DATA FRAME Sensor → PC (18 WORDS)

0x00AA	SYNC-WORD
8	ORDER-WORD
0	DUMMY
0	DUMMY
0	DUMMY
0	DUMMY
0	DUMMY
0	DUMMY
0	DUMMY
0	DUMMY
0	DUMMY
0	DUMMY
0	DUMMY
0	DUMMY
0	DUMMY
0	DUMMY
0	DUMMY
0	DUMMY

**Example 20: DATA FRAME with ORDER NUMBER = 20**

ORDER NUMBER (second word = 20): SEND LINE OK from the Sensor to PC! Cf. example 1:  
Send the same DATA FRAME but with ORDER NUMBER 20 to the sensor.  
The sensor will reply with the same 18 words but with SYNC-WORD=0x00AA which tell that there is a connection.

**Example 190: DATA FRAME with ORDER NUMBER = 190:**

ORDER NUMBER (second word = 190): Write new baud rate to sensor.

Attention! New baud rate is only in the RAM. To store the new baud rate to EEPROM refer to example 6.

baud rate is coded to:

0	9600 Bit/s
1	19200 Bit/s
2	38400 Bit/s
3	57600 Bit/s
4	115200 Bit/s

The completely data frame = 18 words must be sent to the sensor hardware in binary form **with old baud rate** (sync-word / order-word / 16 parameter words).

**DATA FRAME PC → Sensor (18 WORDS)**

0x0055	SYNC.-WORD
190	ORDER-WORD
3	new baud rate 57600 Bit/s
0	DUMMY
0	DUMMY
0	DUMMY
0	DUMMY
0	DUMMY
0	DUMMY
0	DUMMY
0	DUMMY
0	DUMMY
0	DUMMY
0	DUMMY
0	DUMMY
0	DUMMY
0	DUMMY
0	DUMMY

**DATA FRAME Sensor → PC (18 WORDS) comes also with old baud rate**

0x00AA	SYNC.-WORD
190	ORDER-WORD
3	new baud rate 57600 Bit/s
0	DUMMY
0	DUMMY
0	DUMMY
0	DUMMY
0	DUMMY
0	DUMMY
0	DUMMY
0	DUMMY
0	DUMMY
0	DUMMY
0	DUMMY
0	DUMMY
0	DUMMY
0	DUMMY
0	DUMMY

**FROM now the sensor works with the new baud rate.**