

Operating Instructions

Software TLB-CON10-Scope V1.1

(PC software for Microsoft® Windows® Vista, XP, 2000, NT® 4.0, 98)

for electronic control unit TLB-CON10-FIO
- leadframe application -

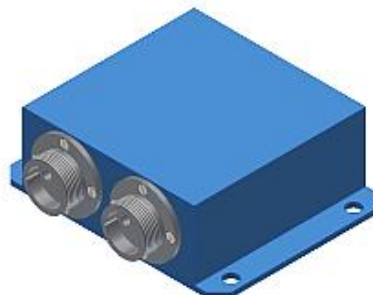
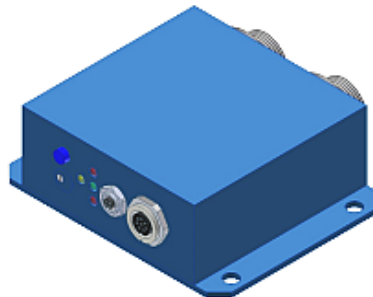
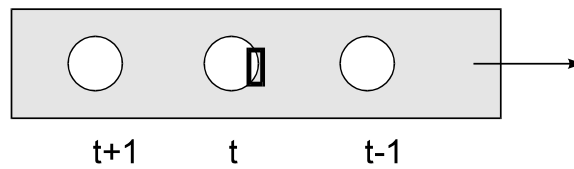

0 Table of Contents

Chapter	Page
1. Functional principle: Electronic control unit <i>TLB-CON10-FIO</i>.....	3
1.1 Technical description.....	3
2. Installation of the <i>TLB-CON10-Scope software</i>.....	4
3. Operation of the <i>TLB-CON10-Scope software</i>.....	6
3.1 Control elements of the <i>TLB-CON10-Scope software</i>	7
3.2 Numeric and graphic display elements	11
3.3 Serial RS232 data transfer	13
3.4 <i>TLB-CON10-Scope</i> as an aid for sensor adjustment.....	14
4. Evaluation algorithms, leadframe application	15
4.1 Raw data	15
4.2 Maximum values.....	15
4.3 Standardized measuring values	15
4.4 Examples for calculation of analog values	16
5. Annex	17
5.1 Dimensions of electronic control unit <i>TLB-CON10-FIO</i>	17
5.2 Dimensions of optical fibers	18
5.3 Function of the digital inputs <i>IN0</i> and <i>IN1</i>	19
5.4 Connector assignment	20
5.5 RS232 interface protocol.....	21

1 Function principle: Electronic control unit *TLB-CON10-FIO*

1.1 Technical description

The *TLB-CON10-FIO* control unit serves for connecting two optical fibres and for evaluating their output signals. The two optical fibres each consist of a transmitter fibre bundle and a receiver fibre bundle. With the electronic control unit the transmitter power of an IR transmitter diode can be separately adjusted for each of the two channels.

The microcontroller of the *TLB-CON10-FIO* control unit can be parameterised through the serial RS232 interface by way of a Windows PC software. It is possible to set various operating modes. The housing of the control unit features a TEACH/RESET button and a potentiometer for tolerance setting. Switching states are visualised by means of 4 LEDs (1x green, 1x yellow, and 2x red) that are integrated in the housing of the *TLB-CON10-FIO* control unit. The control unit has two digital outputs (OUT0 – BUSY and OUT1 – ERROR). An external RESET function and a START/STOP cycle can be realised through a PLC via two digital inputs (IN0-RESET and IN1-START/STOP). The control unit furthermore provides two high-speed analog outputs (0 ... +10V) with 12-bit digital/analog resolution.

LED display (red/green/red):
 LED red (+): status OUT1 (error MAX-LIMIT)
 LED green: trigger indication
 LED red (-): status OUT1 (error MAX-DELTA)

RESET button:
 Pushing of the button:
 < 0.75 s = RESET

Potentiometer for
 tolerance setting

4-pole fem. connector
 Binder series 707
 (RS232 interface)

Connecting cable:
 cab-las4/PC-...

8-pole fem. connector
 Binder series 712
 (PLC connection)

Connecting cable:
 cab-las8/SPS-...

Adapter for
 optical fiber
 D-S-Q*6.8x5x25-
 (1.2x0.3)-1200-22°
 → only for use
 at CHA!

CHA

CHB

Adapter for
 standard optical
 fiber

Mounting
 holes

2 Installation of the *TLB-CON10-Scope* software

Hardware requirements for successful installation of the *TLB-CON10-Scope* software:

- 200 MHz Pentium-compatible processor or better.
- CD-ROM or DVD-ROM drive
- Approx. 10 MB of free hard disk space
- SVGA graphics card with at least 800x600 pixel resolution and 256 colors or higher.
- Windows 98, Windows NT4.0, Windows 2000, Windows XP, or Windows Vista operating system
- Free serial RS232 interface or USB port with USB-RS/232 adaptor at the PC

Please install the *TLB-CON10-Scope* software as described below:

1.  **CD-Laufwerk (D:)** Insert the installation CD-ROM in your CD-ROM drive. In our example we suppose that this is drive "D".

2.  **setup.exe** Start the Windows Explorer and in the folder tree of your CD-ROM drive go to the installation folder D:\Install\ .
Then start the installation program by double-clicking on the SETUP.EXE symbol.

As an alternative, software installation can also be started by clicking on **START-Run...** and then entering "D:\Install\setup.exe", which must be confirmed by pressing the **OK** button.



The installation program then displays a dialog box for *TLB-CON10-Scope* installation. This dialog box shows some general information about installation.

Click on Next> to start the installation

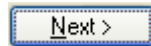

or on **C**ancel to quit the installation of the *TLB-CON10-Scope* software.

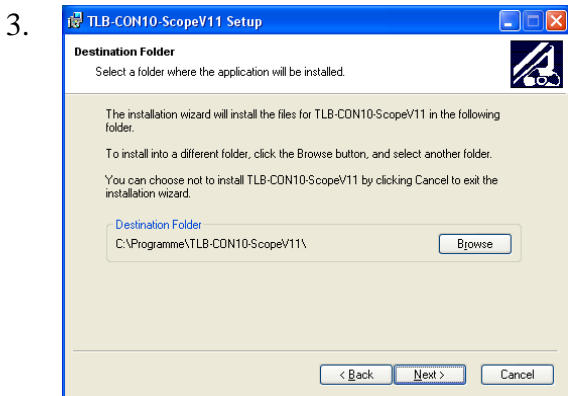
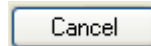

When you click on the Next> button, a new dialog appears for selecting the folder where the application will be installed (destination folder).

You may accept the suggested folder with Next>, or you may change the installation folder as desired by clicking on the Browse button.

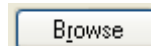

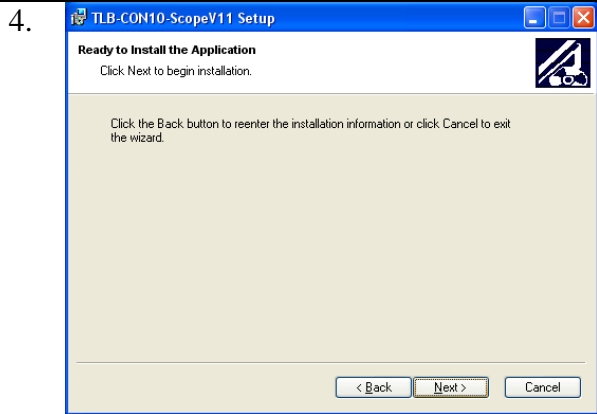

Another *TLB-CON10-Scope* Setup dialog will be displayed.

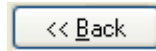

Click on the Back button if you want to change the installation folder again.



Click on Next>> to start the installation, or

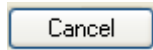

click on Cancel to quit the installation process.

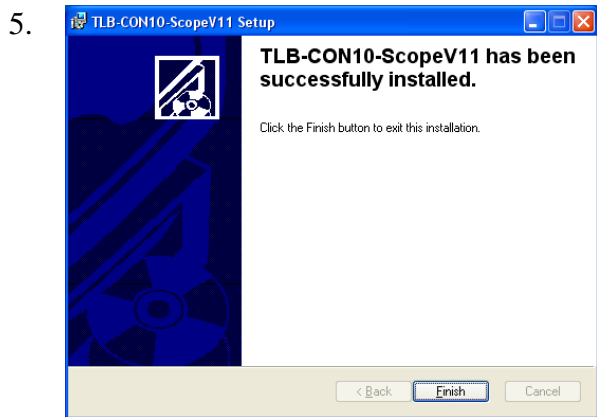

When installation is completed, a dialog box informs you about successful installation.

A new *TLB-CON10-Scope* program group has been created under Start-All-Programs.



Click on the Finish button to finish the installation.



The *TLB-CON10-Scope* software can now be started by clicking on the respective icon in the newly created program group under:

Start >All Programs > TLB-CON10-ScopeV1.1

Deinstallation of the *TLB-CON10-Scope* Software:



Please use the Windows deinstallation tool to remove the software.

The Windows deinstallation tool can be found under Start / Settings / Control Panel.

3 Operation of the TLB-CON10-Scope Software

The *TLB-CON10-Scope* software is used for parameterizing the electronic control unit used via the serial interface. The measured values provided by the two optical fibers can be visualized with the PC software, which means that the software among others can be used for adjustment purposes and for setting suitable tolerance limits for the inspection of the measuring object.

Data exchange between the PC user interface and the TLB-CON10-FIO electronic control unit is effected through a standard RS232 interface. For this purpose the TLB-CON10-FIO is connected to the PC with the serial interface cable cab-las-4/PC. When parameterization is finished, the setting values can be permanently saved in an EEPROM memory of the *TLB-CON10-FIO* control unit. The sensor system then continues to operate in "STAND-ALONE" mode without PC.

When the *TLB-CON10-Scope* software is started, the following Windows® user interface will be displayed:

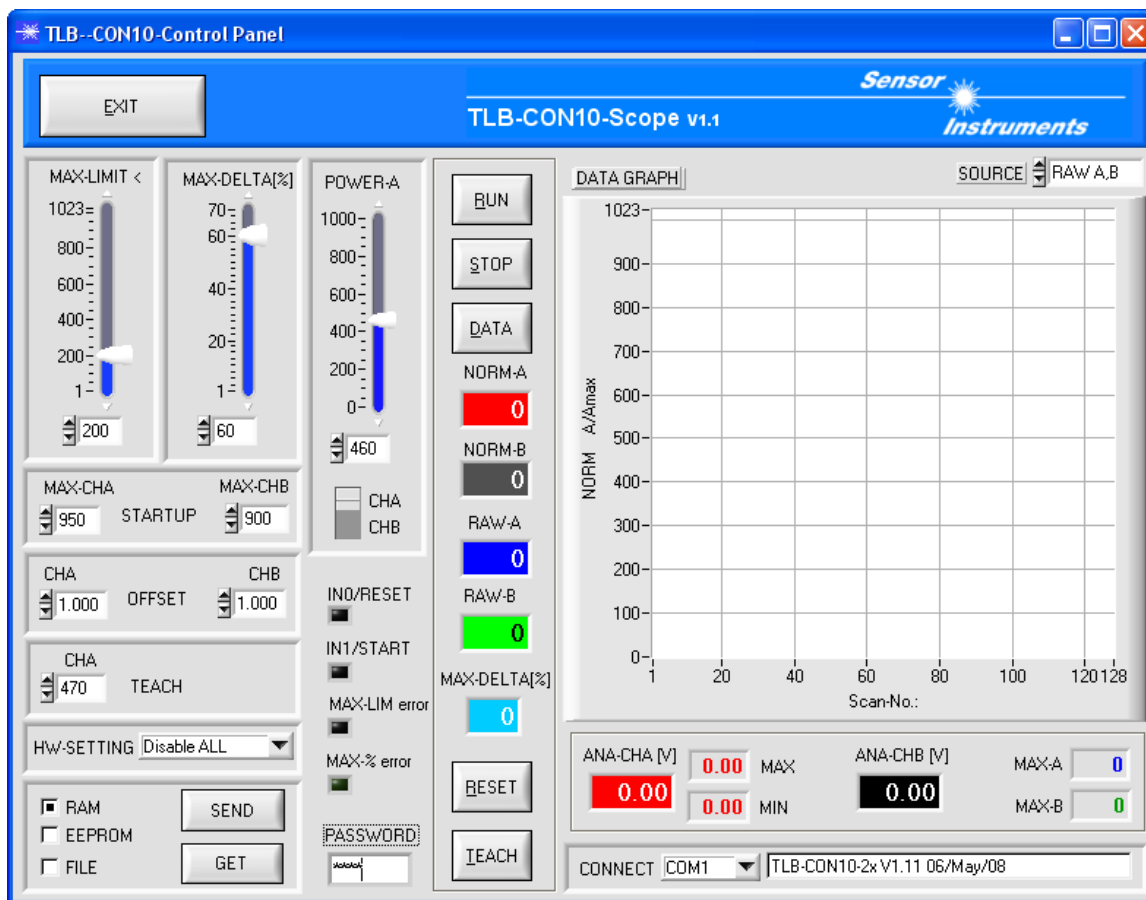

The *TLB-CON10-Scope* CONTROL PANEL provides a great variety of functions for parameterization of the electronic control unit:

- Visualization of measurement data in numeric and graphic output fields.
- Setting of the laser power for the respective measuring channel CHA and CHB.
- Presetting of setpoint values and tolerance values.
- Saving of parameters to the RAM, EEPROM memory of the control unit, or to a configuration file on the hard disk of the PC.

The following chapters provide explanations of the individual control elements of the TLB-CON10-Scope software.

3.1 Control elements of the *TLB-CON10-Scope* software:

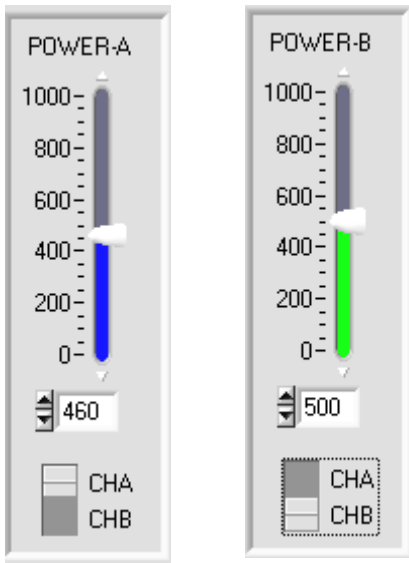

POWER-A, POWER-B:

In this function field the transmitter power at the respective measuring channel at the *TLB-CON10-FIO* control unit can be set by clicking the arrow keys, by moving the slider, or by entering a numerical value in the corresponding input field.



This change-over switch is used for selecting either the measuring channel CHA (blue) or the coarse adjustment channel CHB (green).



Attention !



Changes that are made in these function fields only become active at the *TLB-CON10-FIO* control unit when the SEND button is pressed!

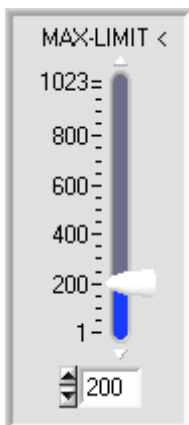

MAX-LIMIT <:

This slider or the value that is entered in the edit box defines the default value for the lower threshold for maximum value monitoring at measuring channel CHA. During feed operation the aperture of the optical fibre is fully set free by the hole of the measuring object (leadframe strip). This is used for determining the current maximum value *act_max* at the receiver unit of the respective measuring channel (raw data: 10-bit value range, 0 .. 1023 ADC- units).

ERROR if: $act_max < MAX_LIMIT$

If the current maximum value at measuring channel CHA (*act_max* = mean value of the last four maximum values) lies below the MAX-LIMIT < threshold that is set here, the error output OUT1/pin6/pink will be activated. The red LED (+) at the housing of the *TLB-CON10-FIO* control unit will light up.

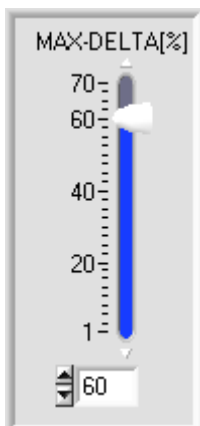

MAX-DELTA[%]:

In this function field a tolerance band within the limits of which the maximum values (*act_max*) may lie is defined by way of the slider or by entering a value in the numerical field. The numerical value MAX-DELTA[%] refers to the relative deviation of the quotient $\frac{delta_max}{act_max}$.

ERROR if:

$$\left| 100 \cdot \frac{delta_max}{act_max} > MAX_DELTA[\%] \right|$$

(*act_max* = mean value of the last four maximum passages).

If the calculated quotient is higher than the MAX-DELTA[%] value that is set here, the error output OUT1/pin6/pink will be activated. The red LED (+) at the housing of the *TLB-CON10-FIO* control unit will light up.



MAX-CHA, MAX-CHB:

The start values for measuring channel CHA and CHB can be set with these arrows or by entering numerical values in the corresponding fields. The maximum values that are set here are used as start values when the *TLB-CON10-FIO* control unit is initialised. The start values must first be permanently stored in the non-volatile EEPROM, if they should be used as start values by the control unit when the system is started up.



OFFSET CHA, CHB:

By way of two input fields this window allows separate fine calibration of the analog outputs for both channels CHA and CHB. When a value is entered in the corresponding numerical input field, this defines a pre-factor that modifies the analog signal at the corresponding analog output.

The possible value range for this pre-factor is: 0.750 ... 1.250

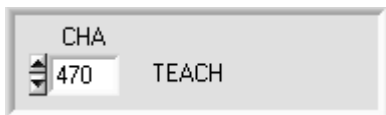

TEACH CHA:

This function field serves for presetting a setpoint value for the positioning of the measurement object relative to the measuring aperture at channel CHA. Because of maximum value referencing (A/A_{max}) to the 10-bit value range the teach values lie between 1 and 1023. Optimally the teach values should lie at approximately half covering of the measuring aperture (approx. 500 NORM units).

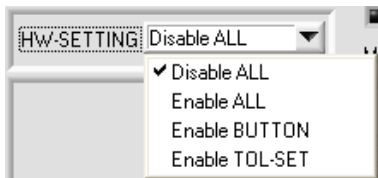

HARDWARE -SETTING:

The TOLERANCE potentiometer and/or the TEACH/RESET button at the sensor housing of the *TLB-CON10-FIO control unit* can be activated (ENABLE) or deactivated (DISABLE) by clicking on the respective item in the list selection field.

The TOLERANCE potentiometer allows the presetting of the MAX-LIMIT < value. If the function field is set to ENABLE ALL or ENABLE TOL-SET, it is not possible to enter numerical values for MAX_LIMIT in the TOLERANCE-VALUE input field on the PC software user interface. The respective function field will be greyed out.

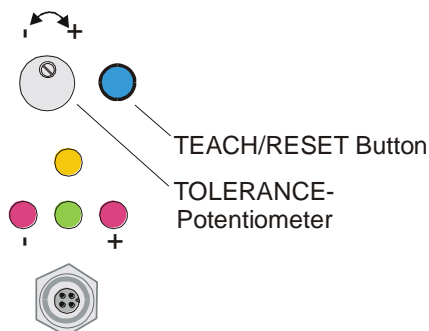

DISABLE ALL

Both the TEACH/RESET button and the TOLERANCE potentiometer at the housing are deactivated.

ENABLE ALL:

The potentiometer at the housing is activated.

(clockwise turning increases the tolerance bandwidth)

The TEACH/RESET button at the housing is activated.

Button pressed for a short time ($t < 0.7s$) : RESET current maximum values.

Button pressed for a longer time ($t > 1.5s$) : TEACH function.

ENABLE BTN:

Only the TEACH/RESET button at the housing is activated.

ENABLE T-SET:

Only the TOLERANCE potentiometer at the housing is activated.



PASSWORD:

Input field for entering the password. The correct password enables certain input fields on the user interface.

The standard password is "1492"

Password protection can be activated again by entering the password in the input field once again.



The password may comprise a maximum of 10 letters/numerals, special characters must not be used. The password can be changed and saved in the "PW.CFG" file that is located in the working directory of the TLB-CON10-Scope software. The new password will be active when the program is started the next time.



RESET button:

The RESET button performs a software reset at the *TLB-CON10-FIO* control unit. After a software reset the yellow and green LED at the housing will flash shortly, and the operating parameters will be loaded from the EEPROM.

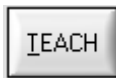

TEACH button:

A click on the TEACH button starts a teach process at the *TLB-CON10-FIO* control unit. The covering of measuring channel CHA is evaluated and is written to the volatile RAM memory of the control unit as a teach value.

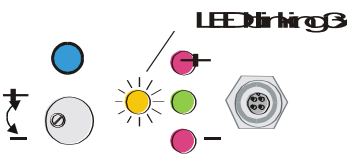

When the teach process is completed the yellow LED at the housing of the *TLB-CON10-FIO* control unit flashes shortly 3 times.

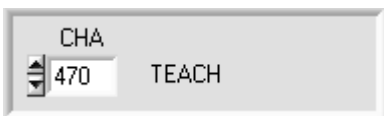

As an alternative the current teach value (setpoint value) also can be set by entering a numerical value in the numeric input field. The teach value that is set by this method will only be activated at the *TLB-CON10-FIO* control unit after a click on the SEND button.

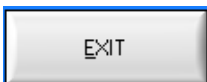

EXIT button:

Pressing the EXIT button closes the TLB-CON10-Scope PC application.

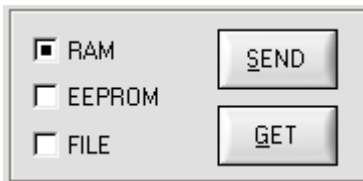

PARAMETER TRANSFER:

This group of function buttons is used for transferring parameters between the PC and the *TLB-CON10-FIO control unit* through the serial RS232 interface.



SEND:

When the SEND button is clicked, the parameters currently set on the user interface are transferred to the *TLB-CON10-FIO control unit*. The target of data transfer is determined by the selected radio-button (RAM, EEPROM, or FILE).

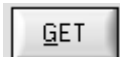

GET:

When the GET button is clicked, the setting parameters are transferred from the *TLB-CON10-FIO control unit* to the PC and are updated on the user interface. The source of data transfer again is determined by the selected radio-button:

RAM:

The currently set parameters are written to the volatile RAM memory of the *TLB-CON10-FIO control unit*, or they are read from the RAM and transferred to the PC. Please note: The parameters set in the RAM will be lost when the power supply at the *TLB-CON10-FIO control unit* is turned off.

EEPROM:

The currently set parameters are written to the non-volatile EEPROM memory of the *TLB-CON10-FIO control unit*, or they are read from the EEPROM and transferred to the PC. Parameters that are saved in the EEPROM will not be lost when the power supply is turned off. If parameters are read from the EEPROM of the *L-LAS-TB control unit*, these must be written to the RAM of the *TLB-CON10-FIO control unit* by selecting the RAM button and then clicking on SEND. The *TLB-CON10-FIO control unit* then continues to operate with the set RAM parameters.

FILE:

When the FILE radio-button is selected, a click on the SEND/GET button opens a new file dialog on the user interface. The current parameters can be written to a freely selectable file on the hard disk of the PC, or parameters can be read from such a file.

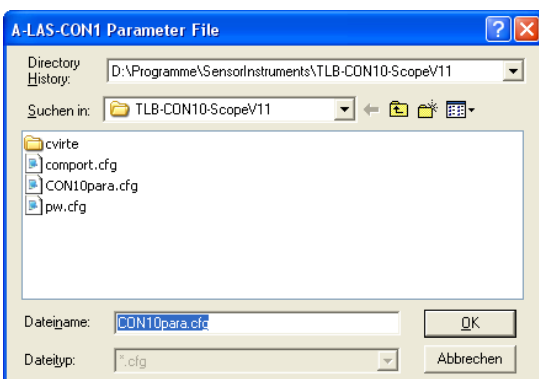

FILE dialog window:

The standard output file for the parameter values has the file name „CON10para.cfg“.

The output file can be opened e.g. with the standard Windows "Editor" program.

3.2 Numeric and graphic display elements:



RUN button:

After a click on the RUN button, the current measurement data will be transferred from the *TLB-CON10-FIO control unit* to the PC via the serial interface.



STOP button:

A mouse-click on the STOP button stops the data transfer between the *TLB-CON10-FIO control unit* and the PC.

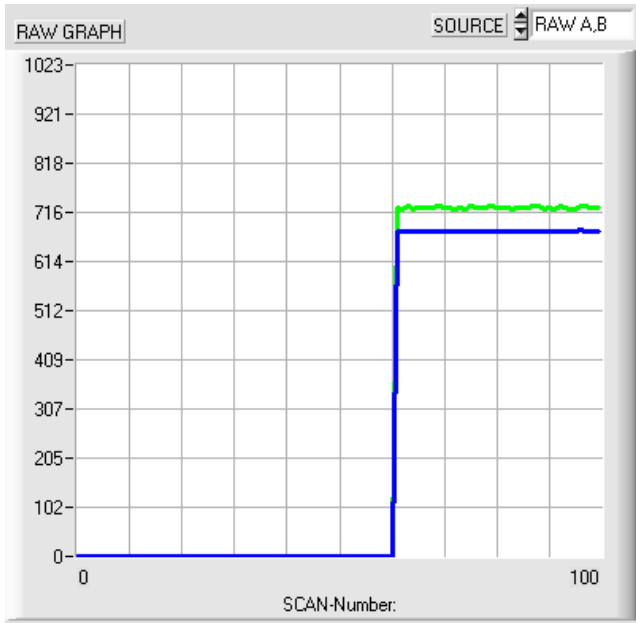

After a click on the RUN button the current measurement values of measuring channel CHA and CHB are shown in the graphic display window in "scroll mode".

The measurement values run through the graphic display window from right to left as a blue (CHA) and green (CHB) curve.

The division of the y-axis corresponds with the value range of 10-bit analog-digital conversion (0 ... 1023).

In the graph the two most recent measurement values are shown at the right end at x-value = 100.

NORM-A
782

NORM-B
978

RAW-A
911

RAW-B
841

MAX-DELTA[%]
0

NORM-A:

Numerical display of the current normalised measurement value of CHA

NORM-B:

Numerical display of the current normalised measurement value of CHB

RAW-A:

Numerical display of the current raw value of CHA (10-bit value range).

RAW-B:

Numerical display of the current raw value of CHB (10-bit value range).

MAX-DELTA[%]:

Numerical display of the current deviation of the last 4 maximum values from the current maximum value at measuring channel CHA.

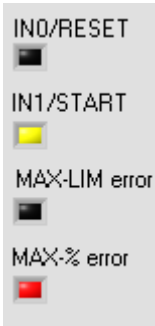

IN0/RESET:

The LED display shows the status at digital input IN0/pin3/green (RESET).

Green: IN0 = HIGH
Black/off: IN0 = LOW

IN1/START:

The LED display shows the status at digital input IN1/pin4/yellow (START/STOP)

Yellow: IN1 = HIGH
Black/off: IN1 = LOW

MAX-LIM error:

The LED display shows the status of error condition "fallen below maximum limit".

Red: Error OUT1=LOW
Black/off: No error: OUT1=HIGH

MAX-% error:

The LED display shows the status of error condition "maximum deviation too high".

Red: Error: OUT1=LOW
Black/off: No error: OUT1=HIGH

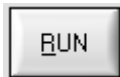

PLEASE NOTE:

The above LED displays are only updated when the RUN button is pressed!



Numerical display fields that are updated after every START/STOP cycle.

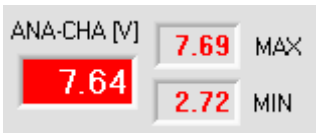

ANA-CHA [V]:

Current analog output voltage at measuring channel CHA.

The two MAX and MIN values show the maximum and minimum values for the analog output voltage that were determined during the last START/STOP cycle.



ANA-CHB [V]:

Current analog output voltage at channel CHB.



MAX-A, MAX-B:

Current maximum values in AD units (10-bit) of channel CHA and CHB.

3.3 Serial RS232 data transfer:

RS232 COMMUNICATION:

- Standard RS232 serial interface without hardware-handshake.
- 3-line-connection: GND, TXD, RXD.
- Speed: 19200 baud, 8 data bits, no parity bit, 1 stop bit in binary mode, MSB first.



Attention !

The stable function of the RS232 interface (status message after program start) is a basic prerequisite for data transfer between the PC and the *TLB-CON10-FIO control unit*. Due to the low data transfer rate of the serial RS232 interface (19200 bit/s) only slow changes of the analog values can be observed in the graphic display at the PC. In order to guarantee the maximum switching frequency of the *TLB-CON10-FIO control unit* it is therefore necessary to stop the data exchange during the normal monitoring process (click on the STOP button).

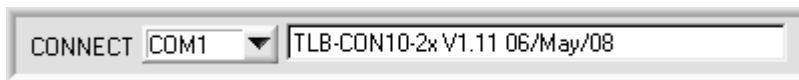

CONNECT:

When the software is started, it attempts to establish a connection to the *TLB-CON10-FIO control unit* through the standard COM1 interface. If connection could be established successfully, the current firmware version is displayed in the status line.

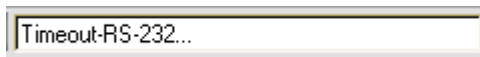

The serial connection between the PC and the *TLB-CON10-FIO control unit* could not be established, or the connection is faulty.

In this case it should first be checked whether the *TLB-CON10-FIO control unit* is connected to the power supply, and whether the serial interface cable is correctly connected to PC and *TLB-CON10-FIO control unit*.

If the number of the serial interface that is assigned at the PC should not be known, interfaces COM1 to COM18 can be selected by using the CONNECT drop-down list.

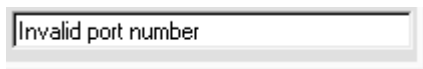

If there is an “Invalid port number” status message, the selected interface, e.g. COM2, is not available at your PC.



If there is a “Cannot open port” status message, the selected interface, e.g. COM2, may already be used by another device.

3.4 TLB-CON10-Scope as an aid for sensor adjustment:

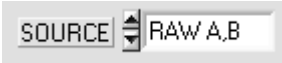

RUN:

After a click on the RUN button, the fine adjustment between the optical fibre transmitter and the optical fibre receiver can be watched for each of the two channels (CHA, CHB) in the RAW-GRAPH display window. For this purpose, the graphic output source (SOURCE) must first be set to RAW A,B.

Please note:

Due to the limited data transfer rate of the RS232 interface only relatively slow changes can be watched at the respective measuring channel.

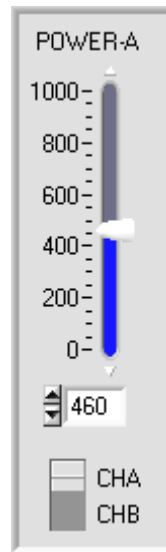
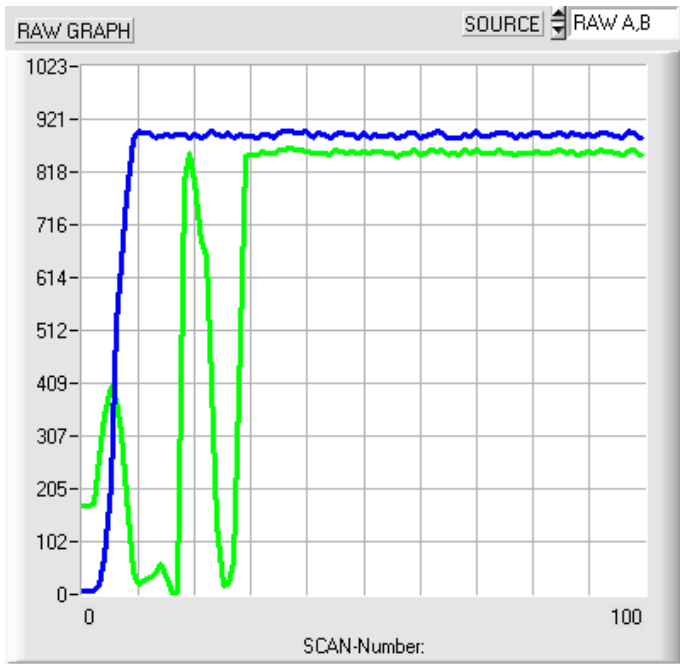

Optimising the adjustment:

First the transmitter power of the IR-LED must be set to a fixed value at the control unit. By watching the raw signals the optical fibre transmitter then should be set relative to the optical fibre receiver in such a way that the raw signals reach their maximum.

Always take care that the analog electronics unit is not overdriven.

The raw signals should not be above 900 AD units. If necessary, the transmitter power must be reduced a little.

4 Evaluation algorithms / lead frame application

4.1 Raw data:

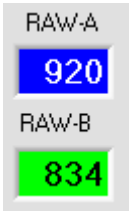

10 bit analog/digital conversion, raw data, depends on IR-LED transmitter power set with POWER.

RAW-A: Measuring channel CHA, optical fiber with rectangular optics (1.2 x 0.3mm)

RAW-B: Measuring channel CHB, optical fiber standard version with circular optics

4.2 Maximum values:



The maximum values are determined and updated within every START/STOP PLC-cycle (IN1-yellow-Pin4).

After the first low/high START edge applied by the PLC the latest maximum and minimum values are reset. After this the current maximum/minimum values are updated by a "drag-pointer-principle" until the STOP low/high transition is detected at IN0. The latest determined maximum values are stored in a separate ring-buffer (4-elements deep) for CHA and CHB. Within every main-loop the mean value of this ring-buffer is calculated separately for channel CHA and CHB. These mean-values are displayed in the MAX-A and MAX-B output fields.

4.3 Standardized measuring values:

	<p>Measurement values and teach-values are based on the actual maximum-values:</p> $CH_A = 1023 * \frac{RAW_A}{MAX_A} \qquad CH_B = 1023 * \frac{RAW_B}{MAX_B}$ $NORM_A = \frac{1023}{2} - \frac{(TECH_A - CH_A)}{2}$ $TEACH_A = 1023 * \frac{RAW_A\#}{MAX_A\#} \qquad \# := \text{values at teach-point in time}$ $NORM_B = CH_B$
--	--

<p>Analog output:</p>	<p>0 ... 10V proportional to NORM_A (measurement-channel) and NORM_B Offset-correction-factors (range 0.75 ... 1.25)</p> $ANA_A[V] = \frac{10[V]}{1023} OFFSET_A * NORM_A$ $ANA_B[V] = \frac{10[V]}{1023} OFFSET_B * NORM_B$
-----------------------	--

4.4 Examples for calculation of analog values for CHA:

Ideal teach value at half covered aperture $TEACH_A = 1023 * \frac{400}{800} = 512$
<p><u>SENSOR uncovered:</u> RAW_A = 800, MAX_A = 800, OFFSET_A=1.0</p> <p>Referenced value: $CH_A = 1023 * \frac{800}{800} = 1023$</p> <p>Measurement value (uncovered) $NORM_A = \frac{1023}{2} - \frac{(512 - 1023)}{2} = 768$</p> <p>Analog output: $ANA_A = \frac{10[V]}{1023} * OFFSET_A * 786 = 7.5 [V]$</p>
<p><u>SENSOR fully covered:</u> RAW_A = 0, MAX_A = 800 (= latest passage of lead-frame)</p> <p>Referenced value: $CH_A = 1023 * \frac{0}{800} = 0$</p> <p>Mesurement value (uncovered): $NORM_A = \frac{1023}{2} - \frac{(512 - 0)}{2} = 256$</p> <p>Analog output: $ANA_A = \frac{10[V]}{1023} * OFFSET_A * 256 = 2.5 [V]$</p>
<p><u>SENSOR at teach-position:</u> RAW_A = 400, MAX_A = 800 (= latest passage of lead-frame)</p> <p>Referenced value: $CH_A = 1023 * \frac{400}{800} = 512$</p> <p>Measurement value (uncovered): $NORM_A = \frac{1023}{2} - \frac{(512 - 512)}{2} = 512$</p> <p>Analog outputi: $ANA_A = \frac{10[V]}{1023} * OFFSET_A * 512 = 5.0 [V]$</p>

Please note: The analog-output-voltage range depends on the teach-value !

If the teach is not done at the ideal half-covered situation, the above equations are providing a different analog output range, but at the teach-position the analog output voltage is always 5.0V.

Example: Teach at 75% coverage: RAW_A = 600, MAX_A=800, => **TEACH_A = 1023* 600/800 = 767**

SENSOR uncovered: RAW_A = 800; MAX_A=800; NORM_A=1023/2 - (767 - 1023)/2 = 640 = 6.25 V

SENSOR fully covered RAW_A = 0; MAX_A=800; NORM_A=1023/2 - (767 - 0)/2 = 128 = 1.25 V

The analog-output-voltage has always a range of 5 volts!
At the teach-position, the analog-output voltage is always ANA-A = 5.0 V

5 Annex

5.1 Dimensions of electronic control unit TLB-CON10-FIO:

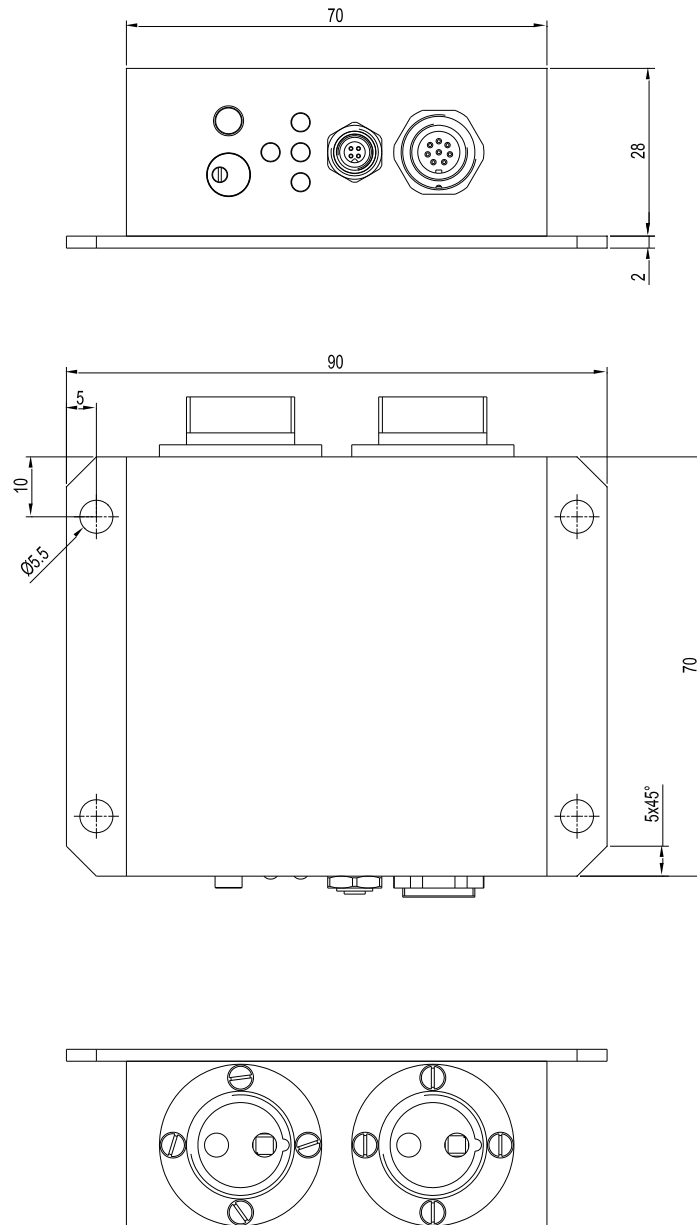

All dimensions in mm

5.2 Dimensions of optical fibers:

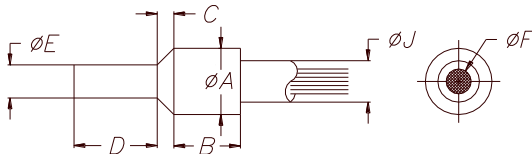
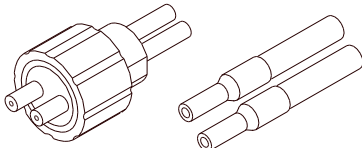
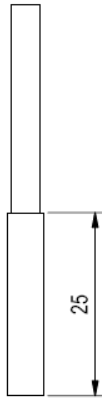
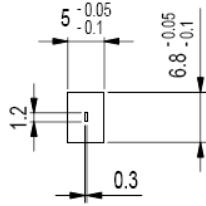
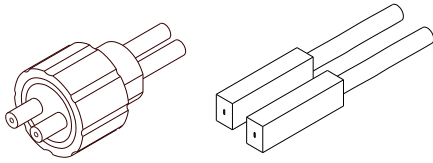

Channel CHA:

D-S-Q*6.8x5x25-(1.2x0.3)-1200-22°

Special version, rectangular cross-section of fibers = 1.2 mm x 0.3 mm

Only for use at measuring channel CHA!

D = Transmitted light operation

S = Silicone metal sheath

Q*6.8x5x25 = Sensor head with special size:
6.8 mm x 5 mm x 25 mm

(1.2x0.3) = Fiber gap 1.2 mm x 0.3 mm

1200 = Total length 1200mm

22° = Beam opening angle

Channel CHB: Standard optical fiber

e.g. D-S-A2.0-(2.5)-1200-22°

D = Transmitted light operation

S = Silicone metal sheath

A2.0 = Sensor head with fiber gap \varnothing 2.5 mm

1200 = Total length 1200mm

22° = Beam opening angle

A = 6,6 mm

B = 10,0 mm

C = 2,0 mm

D = 12,0 mm

E = 4,5 mm

F = 2,5 mm

J = 5,8 mm

5.3 Function of the digital inputs IN0 and IN1

The TLB-CON1-FIO control-unit has two digital inputs IN0 and IN1 that can be contacted through the 8-pole female connector (type Binder 712).

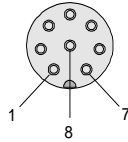
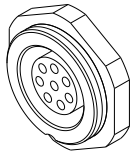

Pin:	Color:	Assignment:
1	white	0V (GND)
2	brown	+24VDC ($\pm 10\%$)
3	green	IN0 (RESET)
4	yellow	IN1 (START/STOP)
5	grey	OUT0 (BUSY)
6	pink	OUT1 (ERROR)
7	blue	ANA_CHA (0 ...+10V)
8	red	ANA_CHB (0 ... +10V)

DIGITAL INPUT IN0 (Pin3/green) RESET:

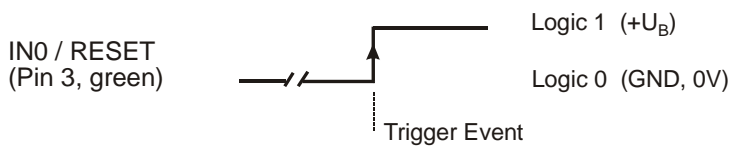

External triggering of the software-reset by applying a LOW/HIGH change at IN0. After a time-span of 750 ms the TLB-CON10 control unit is ready for control-task.

DIGITAL INPUT IN1 (Pin4/gelb) START/STOP-cycles:

START-L/H-edge:

Reset of the latest error-state at OUT1, reset of the latest maxima-values, activation of the new maxima determination.

STOP-L/H-edge:

Evaluation of the latest determined maxima-values, as the case may be set the error-output OUT1

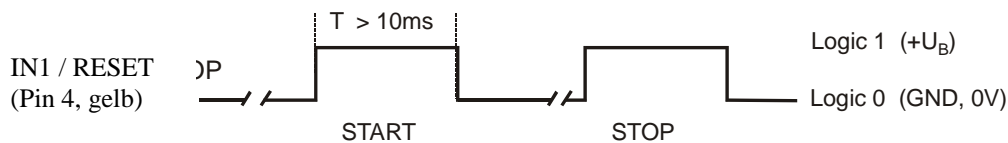

5.4 Connector assignment

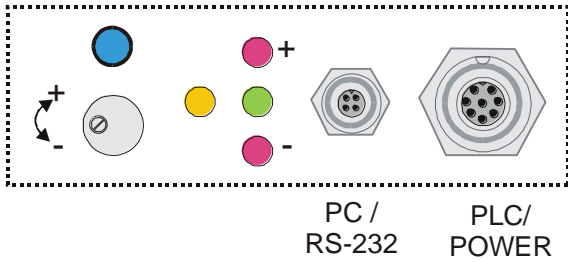

The housing of the TLB-CON10-FIO control unit provides a female connector for power supply connection (8-pole type Binder 712) as well as a female connector for connecting a serial RS232 cable (4-pole type Binder 707).

RS232 connection to PC:

4-pole M5 female connector type Binder 707

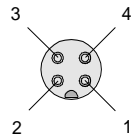

Pin: Assignment:

1	+24VDC
2	0V (GND)
3	TxD
4	RxD

Connecting cable:

cab-las4/PC (length 2m, cable jacket: PUR)

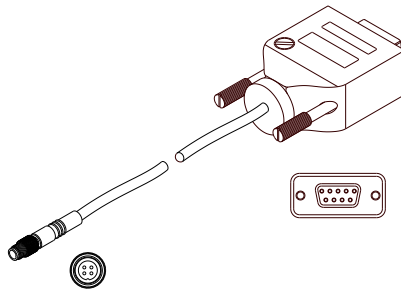

Interface to PLC/power supply:

8-pole female connector type Binder 712

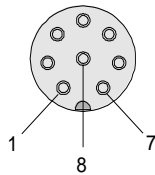
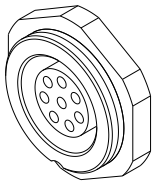

Pin: Colour: Assignment:

1	white	0V (GND)
2	brown	+15VDC ... +30VDC
3	green	IN0 (RESET)
4	yellow	IN1 (START/STOP)
5	grey	OUT0 (BUSY)
6	pink	OUT1 (ERROR)
7	blue	ANA_CHA (0 ... +10V)
8	red	ANA_CHB (0 ... +10V)

Connecting cable:

cab-las8/SPS (length 2m, cable jacket: PUR)

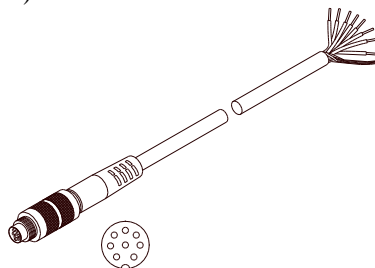

5.5 RS232 interface protocol

RS232 interface protocol PC ↔ TLB-CON10 electronic control unit Firmware version 1.1

- Standard RS232 serial interface, no hardware handshake
 - 3-line connection: GND, TXD, RXD
 - Speed: 19200 baud, 8 data-bits, no parity-bit, 1 stop-bit, binary-mode
 The control device (PC or PLC) must send a data frame consisting of 18-words (1 word = 2 byte = 16 bit) to the TLB-CON10 control unit. All words in the data frame must be transferred in binary format. The higher-order byte must be transferred first (MSB-first).

METHOD:

The microcontroller in the TLB-CON10 sensor permanently reads the input buffer of its RS-232 module (polling). If the arriving word is *0x0055* (0x55 hexadecimal = 85 decimal), this is interpreted as a synchronisation event: (<sync-word>). The microcontroller then reads the order number (<order-word>) that is transferred with the 2nd word.

After the order word (<order-word>) another word is transferred that informs about the number of the parameter set (<para-set>). This is followed by additional 15 words <parameter-word> that contain the actual parameters.

When the complete data frame (18 words = 36 bytes) has been read in, the TLB-CON10 control unit starts to execute the order contained in the 2nd word (<order-word>).

DATA FRAME: PC/PLC → SENSOR (18-Words=36Bytes, MSB first)

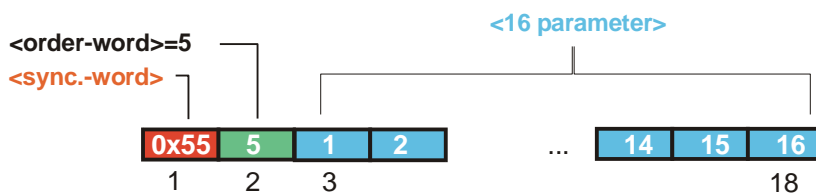

Format of the data frame:

Word No.	Meaning	Comment
1	<sync-word>	hex-code 0x55, binary=0000 0000 0101 0101, dec.=85
2	<order-word>	Order word (see table below)
3	POWER-CHA	Transmitter power (0 ... 1000) measurement channel CHA
4	POWER-CHB	Transmitter power (0 ... 1000) channel CHB
5	MAX-LIMIT<	Lower limit for maxima check (1 ... 1023)
6	MAX-DELTA	Upper limit, allowed maxima-change (1 ... 700) = (1% - 70%)
7	STARTUP_CHA	Startup-value for maxima at CHA (1 ... 1023)
8	STARTUP_CHB	Startup value for maxima at CHB (1 ... 1023)
9	OFFSET_CHA	Offset- factor CHA (0.75 ... 1.25) x1024 (= 768 ... 1280)
10	OFFSET_CHB	Offset- factor CHB (0.75 ... 1.25) x 1024 (= 768 ... 1280)
11	HW-SETTING	(0=Disable All, 1=Enable All, 2=Enable Button, 3=Enable Potentiometer)
12	TEACH_CHA	Teach-value of CHA (1 ... 1023)
13	FREE USE	0
14	FREE USE	0
15	FREE USE	0
16	FREE USE	0
17	FREE USE	0
18	FREE USE	0

Meaning of the 2. word in the data frame: <order-word>		
Wert	Meaning / Action	
0	Nop	no operation
1	Send parameters from PC to TLB-CON10	18 words, PC ⇒ TLB-CON10-RAM
2	Get parameters from TLB-CON10	18 words, TLB-CON10-RAM ⇒ PC
3	Send parameters from PC to TLB-CON-EEPROM	18 words, PC ⇒ TLB-CON10-EE
4	Get parameters from EEPROM of TLB-CON10	18 words, TLB-CON10-EE ⇒ PC
5	Echo check: Get echo-character from TLB-CON10-hardware, line OK = 0x00AA	18 words, first word=0x00AA (Echo=170)
6	Activate teach-procedure, store in EEPROM	18 words PC ⇒ TLB-CON10-EE
7	Get firmware version message of TLB-CON-10	72-bytes, TLB-CON10 ⇒ PC
8	Get measurement data from TLB-CON10	18 words, TLB-CON10 ⇒ PC
9	Get data-buffer information from TLB-CON10	64 words, TLB-CON10-RAM ⇒ PC
13	Activate software reset at TLB-CON10	18 words PC ⇒ TLB-CON10

Examples for the data exchange:

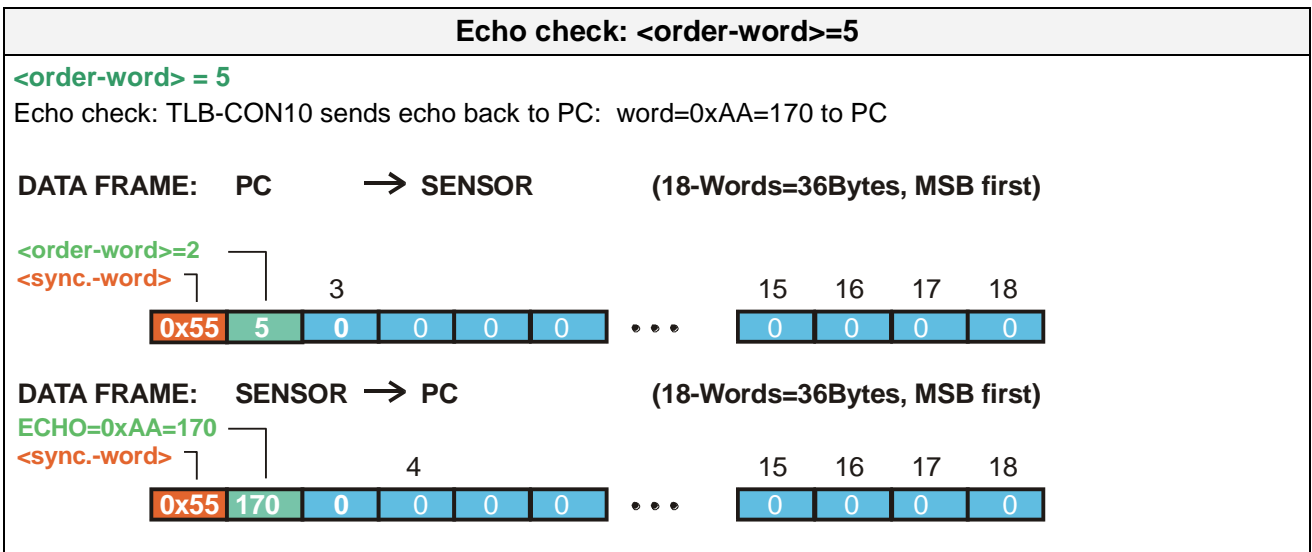

SEND parameters to TLB-CON10 <order-word>=1

<order-word> = 1

Send the actual parameters into the RAM of the TLB-CON10 control unit

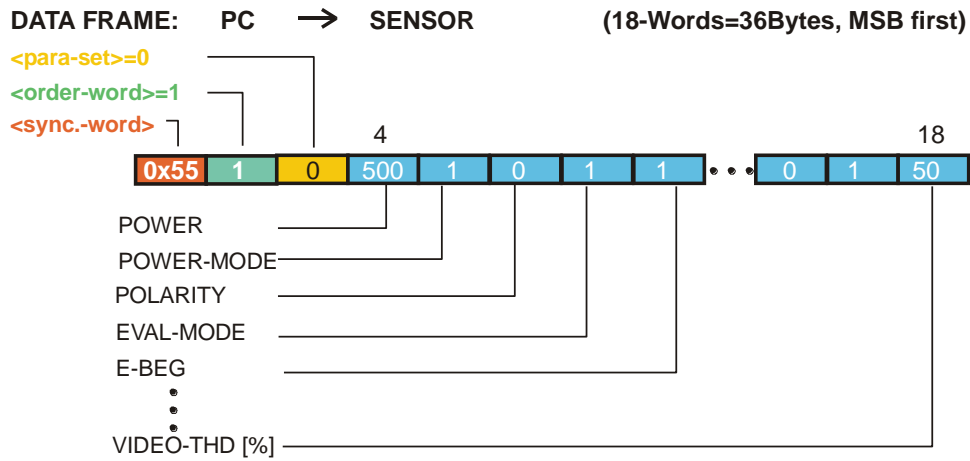

The transferred data frame automatically is sent back as an echo from the sensor!!

GET parameters from TLB-CON10 RAM <order-word>=2

<order-word> = 2

Get the current parameters from TLB-CON10 RAM

DATA FRAME: PC → SENSOR (18-Words=36Bytes, MSB first)

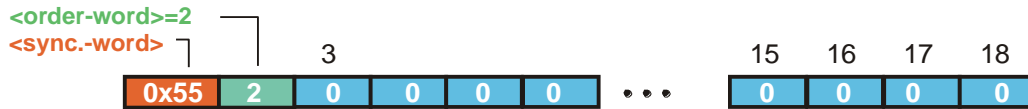

DATA FRAME: SENSOR → PC (18-Words=36Bytes, MSB first)

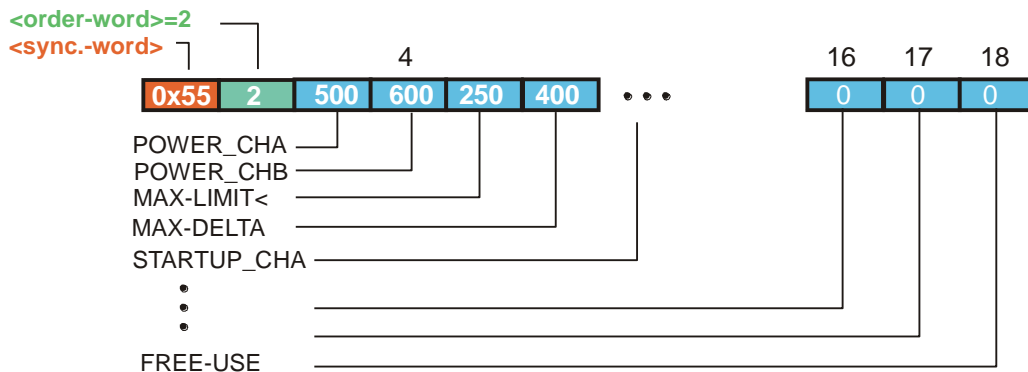

Activate TEACH-PROCEDURE at TLB-CON10 <order-word>=6

<order-word> = 6

Activate teach-procedure at TLB-CON10 control unit.

DATA FRAME: PC → SENSOR (18-Words=36Bytes, MSB first)

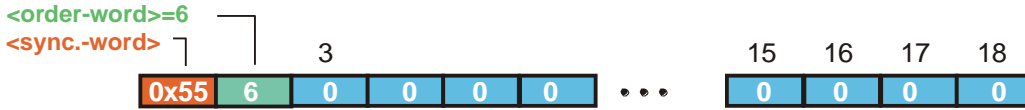

DATA FRAME: SENSOR → PC (18-Words=36Bytes, MSB first)

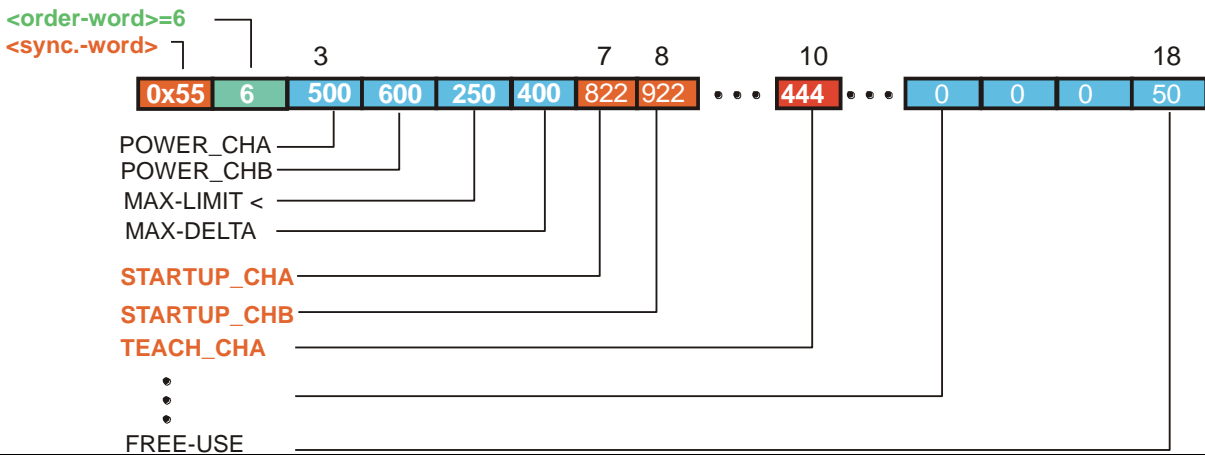

Activate SOFTWARE-RESET at the TLB-CON10 <order-word>= 13

<order-word> = 13

Activate software-reset at the TLB-CON10 control unit!

DATA FRAME: PC → SENSOR (18-Words=36Bytes, MSB first)

