

FIO Series (Accessories)

▶ C-MOUNT-A3.0-180°-100/50

Mounting bracket for transmitted light fiber optics with sensor head type D-S-A3.0-...

- For mounting and optimum alignment of a transmitted light fiber optics type D-S-A3.0-...
- Axial orientation of the two fiber optics heads: 180°
- Distance of the two fiber optics heads: 100 mm
- Fork width 134 mm, fork depth 50 mm
- Fixation of the fiber optics by means of plastic screws
- Sturdy aluminum housing, anodized in black



Design

Product name:

C-MOUNT-A3.0-180°-100/50
(formerly: KL-0/90°-100-A3.0)

(suitable for transmitted light fiber optics D-S-A3.0-..., transmitter/receiver measuring distance 100 mm)

Please order fiber optics separately,
for further information please cf. catalog „FIO Series“

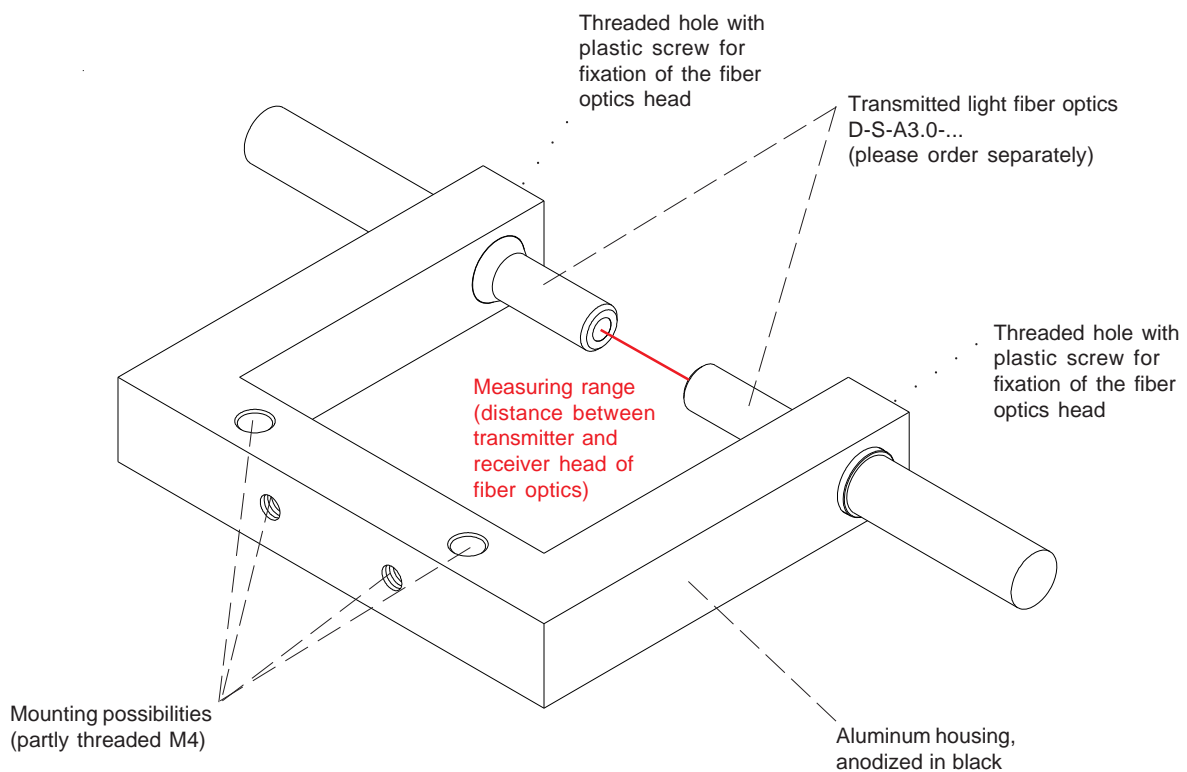



Dimensions

C-MOUNT-A3.0-180°-100/50 (Measuring range 100 mm, fork width 134 mm, fork depth 50 mm)

also available:

C-MOUNT-A3.0-180°-16/50 (Measuring range 16 mm, fork width 50 mm, fork depth 50 mm)

C-MOUNT-A3.0-180°-60/50 (Measuring range 60 mm, fork width 94 mm, fork depth 50 mm)

Typ	A	B
16	50	50
60	94	50
100	134	50

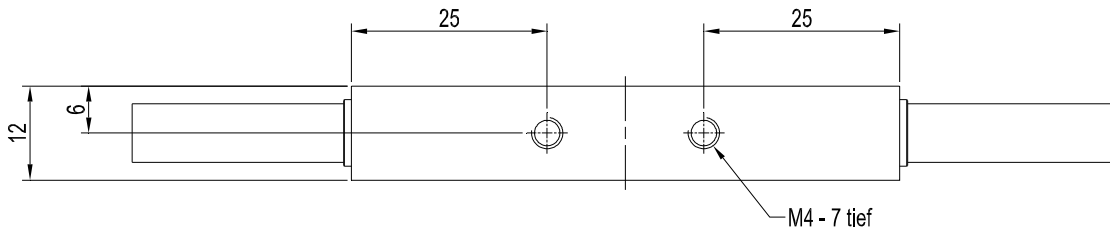
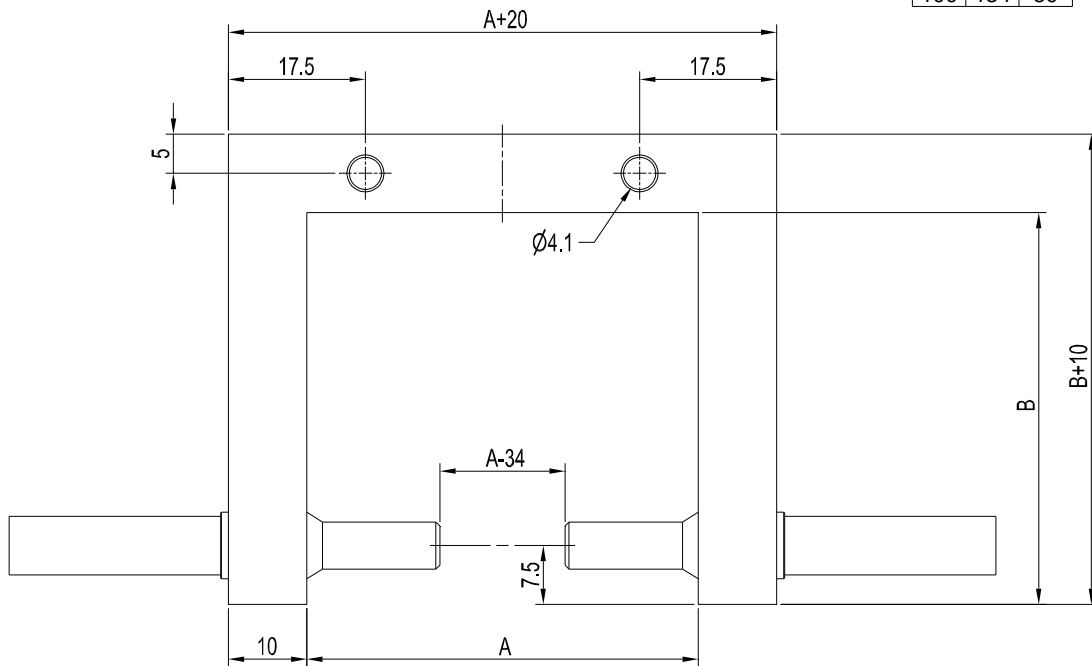

All dimensions in mm



Variants

C-MOUNT-A3.0-180°-16/50

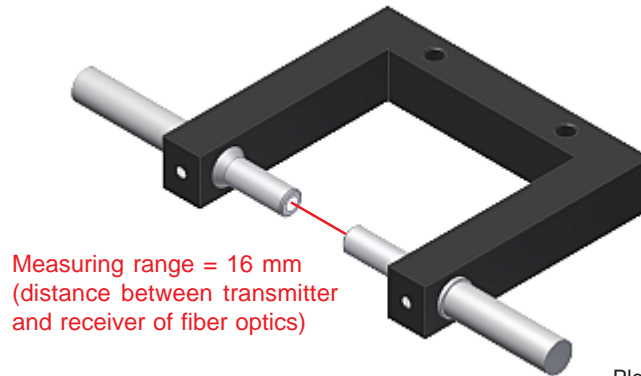

Measuring range = 16 mm
(distance between transmitter
and receiver of fiber optics)

Please order fiber optics
D-S-A3.0-... separately

C-MOUNT-A3.0-180°-60/50

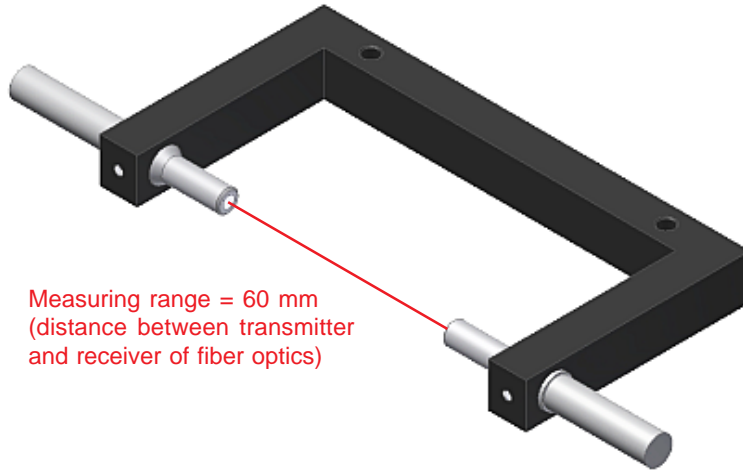

Measuring range = 60 mm
(distance between transmitter
and receiver of fiber optics)

Please order fiber optics
D-S-A3.0-... separately

C-MOUNT-A3.0-180°-100/50

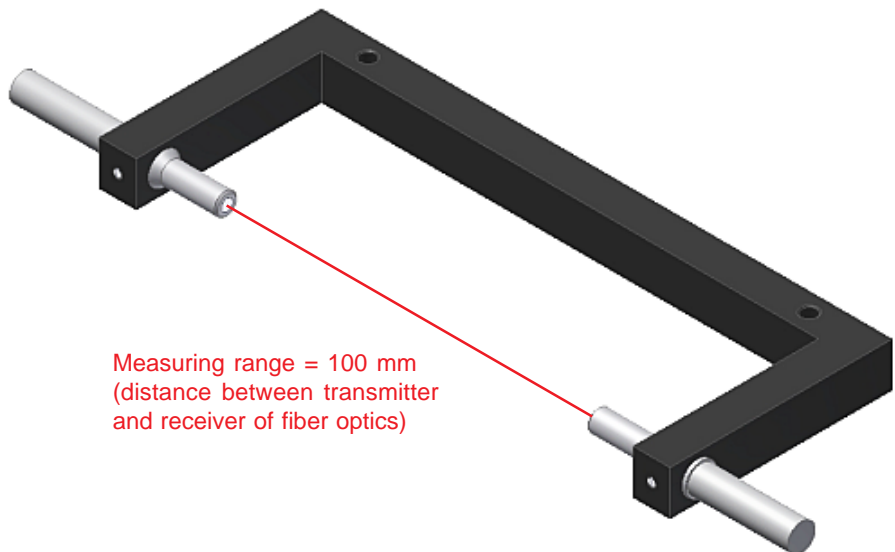

Measuring range = 100 mm
(distance between transmitter
and receiver of fiber optics)

Please order fiber optics
D-S-A3.0-... separately