

Accessories

▶ WFL-8

Mounting flange (angle type 90°) for digital laser light barriers of type D-LAS3

- Exact alignment by means of disk springs
- Sturdy material (aluminum)



Design

Product name:

WFL-8

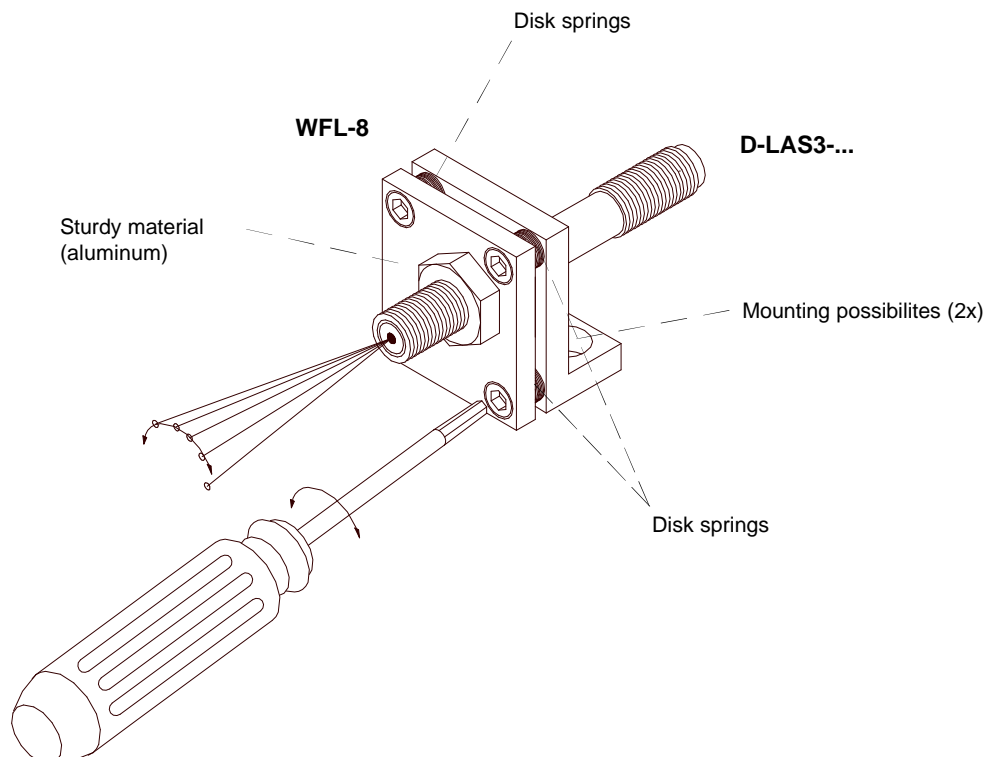



Dimensions

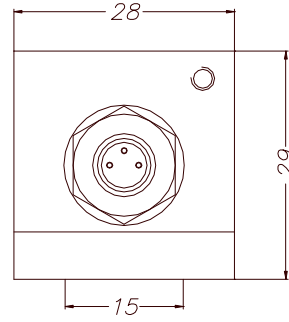
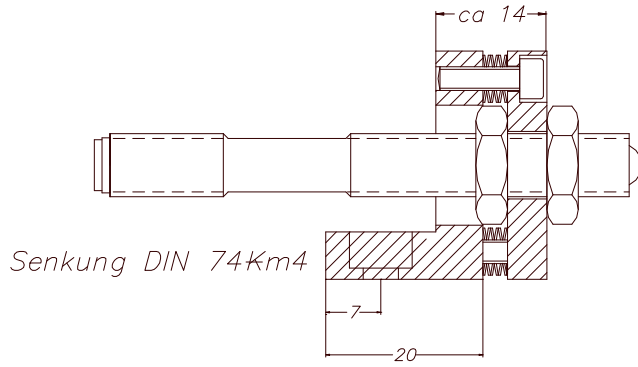

(All dimensions in mm)