

FIO Series (Accessories)

▶ MOUNT-KL-D30-VA

Mounting device for an optical fiber probe type KL-PLNG-BL-A3.0

- Assembly equipment for an optical fiber probe type KL-PLNG-BL-A3.0, for on-site mounting (e.g. in the plastics industry)
- Tube lengths each 500mm
- Variable locking of the mounting arm
- Various mounting possibilities
- All components made of stainless steel (VA or V2A)



Design

Product name:

MOUNT-KL-D30-VA

Suitable for holding an optical fiber probe KL-PLNG-BL-A3.0 (please order separately)

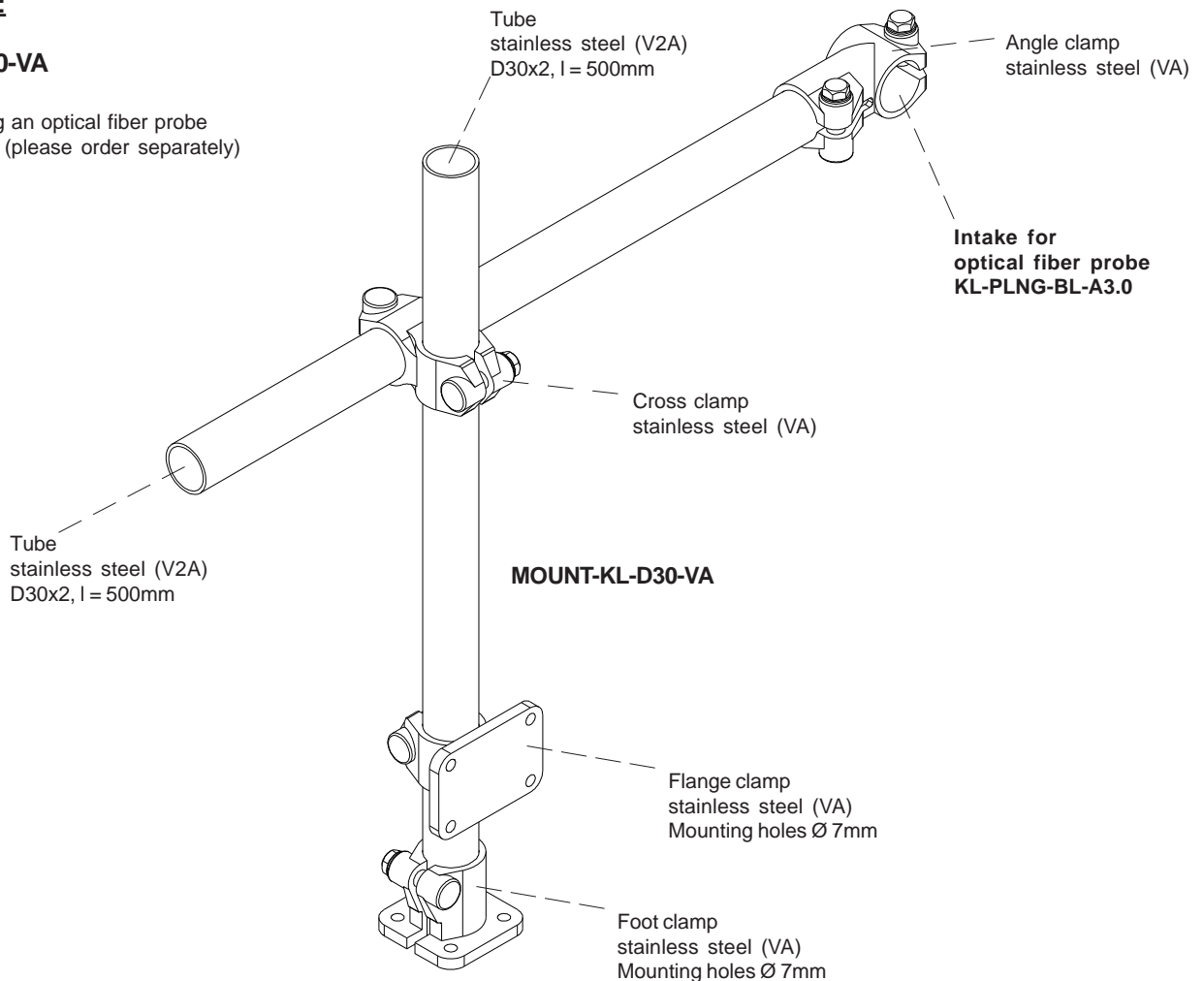



Dimensions

MOUNT-KL-D30-VA

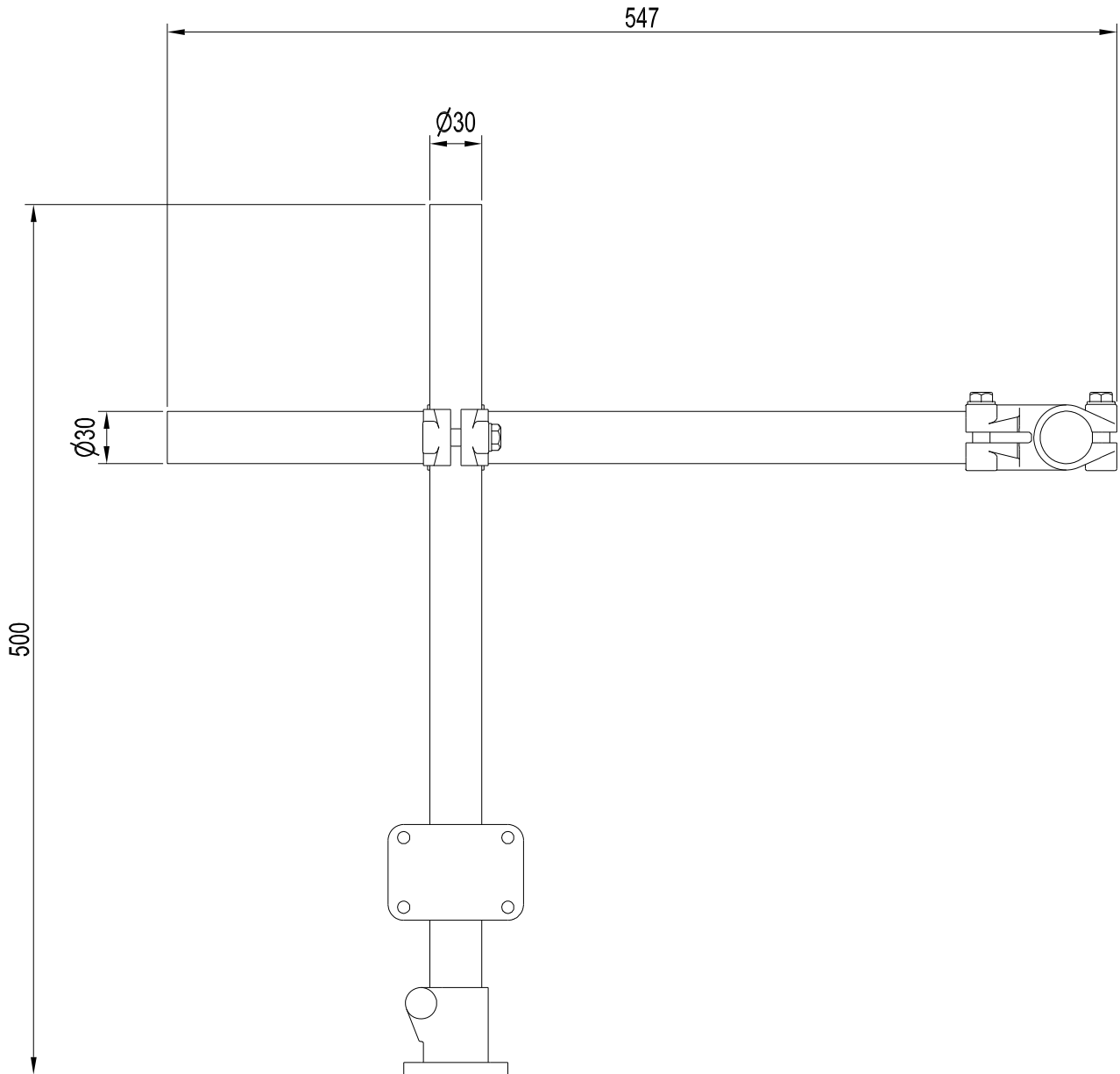

All dimensions in mm

Dimensions

Components of the MOUNT-KL-D30-VA:

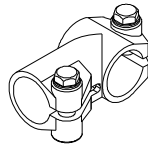
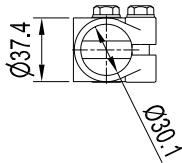
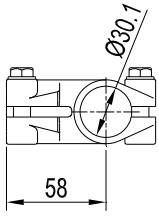

Angle clamp
stainless steel (VA)
W 30

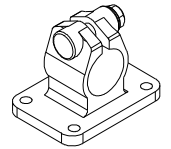
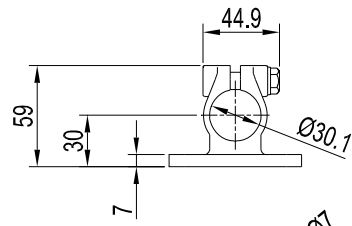
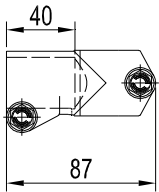

Flange clamp
stainless steel (VA)
FK 30

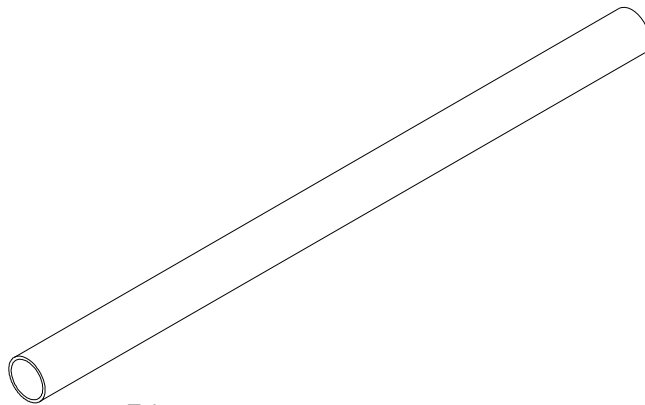
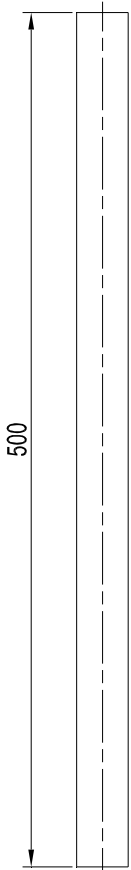
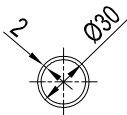
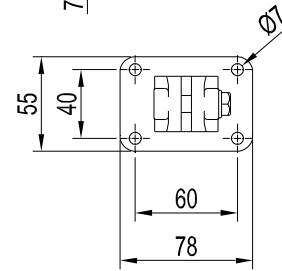

Tube
stainless steel (V2A)
D30x2

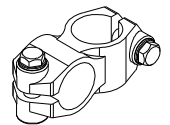
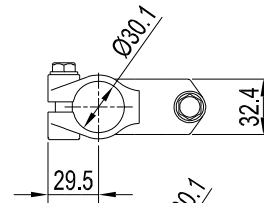

Cross clamp
stainless steel (VA)
K 30

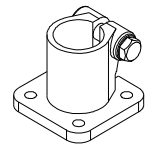
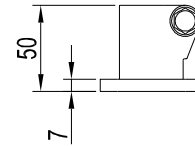
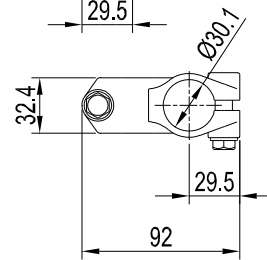

Foot clamp
stainless steel (VA)
FS 30

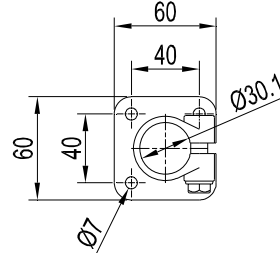

All dimensions in mm



Assembly Sketch

MOUNT-KL-D30-VA
with KL-PLNG-BL-A3.0

