

FIA Series

► FIA-L-S-d0.2-...-RL-TypA-3pol

- Visible red laser light
- Class 1 laser product (680 nm, P<0.39 mW) 
- Integrated electronics
- Various fork sizes available
- Laser beam typ. Ø 0.2 mm
- Insensitive to dirt accumulation, insensitive to outside light
- Optical long-pass filter
- High switching frequency (typ. 50 kHz)
- Switching state indication (red/green LED)
- Scratch-resistant optics
- 3-pole M8-connector (180° rotated compared to the standard version)
- Sturdy aluminum housing, compact design



Design

Product name:

FIA-L-S-d0.2-(fork size)-(switching output)-RL-TypA-3pol

Laser beam diameter:
d0.2 (Ø 0.2 mm)

- Available fork sizes:** (cf. dimensions page 3)
- 10/30** (fork width A=10 mm, fork depth B=30 mm)
 - 20/30** (fork width A=20 mm, fork depth B=30 mm)
 - 20/40** (fork width A=20 mm, fork depth B=40 mm)
 - 25/50** (fork width A=25 mm, fork depth B=50 mm)
 - 25/80** (fork width A=25 mm, fork depth B=80 mm)
 - 30/30** (fork width A=30 mm, fork depth B=30 mm)
 - 30/40** (fork width A=30 mm, fork depth B=40 mm)
 - 40/30** (fork width A=40 mm, fork depth B=30 mm)
 - 40/40** (fork width A=40 mm, fork depth B=40 mm)
 - 40/60** (fork width A=40 mm, fork depth B=60 mm)
 - 60/60** (fork width A=60 mm, fork depth B=60 mm)

Switching output:
Q pnp bright-switching / npn dark-switching
Qinv pnp dark-switching / npn bright-switching

Switching state indication by means of a red/green LED

Receiver optics with long-pass filter

Transmitter optics with visible red laser light beam

Aluminum housing, anodized in black

Mounting holes

3-pole M8-connector

Connecting cable: cab-M8/3-... (cf. page 3)

Typ A
(3-pole M8 connector 180° rotated)

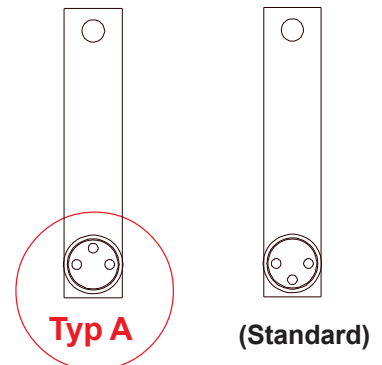



Technical Data

Type	FIA-L-S-d0.2-...-RL-TypA-3pol
Light source	Solid state laser 680 nm, DC operation, 0.39 mW max. opt. power, laser class 1 acc. to DIN EN 60825-1. The use of these laser transmitters therefore requires no additional protective measures.
Laser beam	typ. Ø 0.2 mm
Min. detectable object	typ. 0.2 mm
Reproducibility	typ. 5 µm
Optical filter (receiver side)	long-pass filter
Voltage supply	+24VDC (± 10%), reverse polarity protected
Ambient light	up to 5000 Lux
Current consumption	typ. 20 mA
Aperture size (receiver side)	Circular aperture Ø 0.5 mm
Switching output (1x)	either Q or Qinv: Q = pnp bright-switching (pnp n.c.) / npn dark-switching (npn n.o.) Qinv = pnp dark-switching (pnp n.o.) / npn bright-switching (npn n.c.) 100mA, short-circuit protection
Enclosure rating	IP67
Operating temperature range	-20°C ... +50°C
Storage temperature range	-20°C ... +85°C
Housing material	Aluminum, anodized in black
Housing dimensions	cf. page 3
Connector type	3-pole M8-connector (metal)
EMC test acc. to	DIN EN 60947-5-2 
Switching frequency	typ. 50 kHz
Switching state indicator	red/green LED (detection of an object = LED switches from green to red, the LED is coupled to the digital output OUTPUT INV)



Laser Information

The laser transmitter of FIA-L Series comply with laser class 1 according to EN 60825-1. Under reasonably foreseeable conditions a class 1 laser is safe. The reasonably foreseeable conditions are kept during specified normal operation. The use of these laser transmitters therefore requires no additional protective measures.

The laser transmitter of FIA-L Series are supplied with an information label „CLASS 1 LASER PRODUCT“.

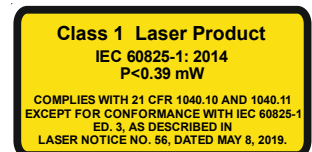

Dimensions

FIA-L-S-d0.2-(fork size)-RL-TypA-3pol:

Fork-size	Dim. A	Dim. B
10/30	10 mm	30 mm
20/30	20 mm	30 mm
20/40	20 mm	40 mm
25/50	25 mm	50 mm
25/80	25 mm	80 mm
30/30	30 mm	30 mm
30/40	30 mm	40 mm
40/30	40 mm	30 mm
40/40	40 mm	40 mm
40/60	40 mm	60 mm
60/60	60 mm	60 mm

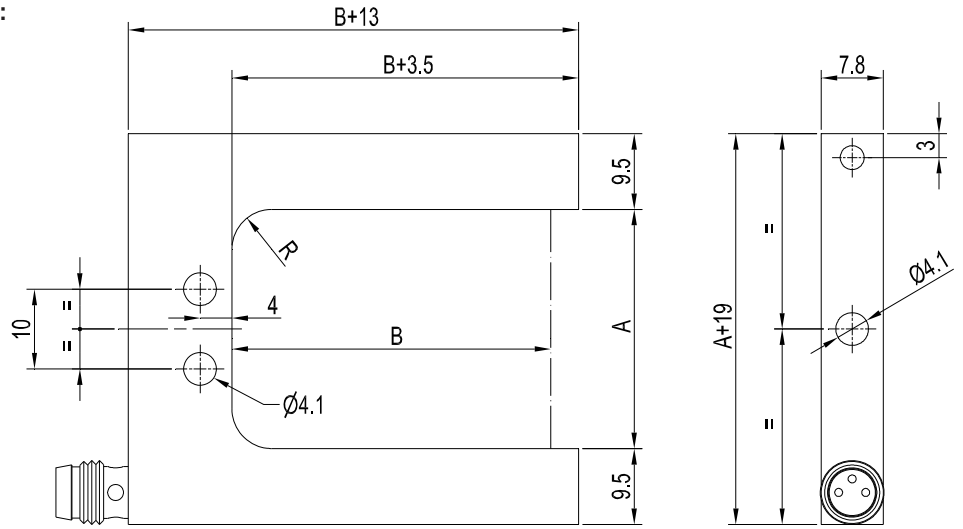

(All dimensions in mm)

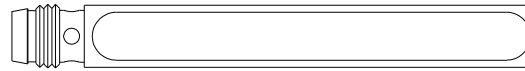

Connector Assignment

FIA-L-S-d0.2-(fork size)-Q-RL-TypA-3pol
(3-pole M8 connector)

- Pin: Assignment:
- 1 +Ub (+24VDC ± 10%)
 - 3 GND (0V)
 - 4 Q: Output
(pnp bright-switching / npn dark-switching)

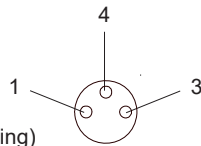

Available connecting cables to PLC:

- cab-M8/3-g-2** (l=2m)
- cab-M8/3-g-5** (l=5m)
- cab-M8/3-w-2** (angle type, l=2m)
- cab-M8/3-w-5** (angle type, l=5m)

FIA-L-S-d0.2-(fork size)-Qinv-RL-TypA-3pol
(3-pole M8 connector)

- Pin: Assignment:
- 1 +Ub (+24VDC ± 10%)
 - 3 GND (0V)
 - 4 Qinv: Output invers
(pnp dark-switching / npn bright-switching)

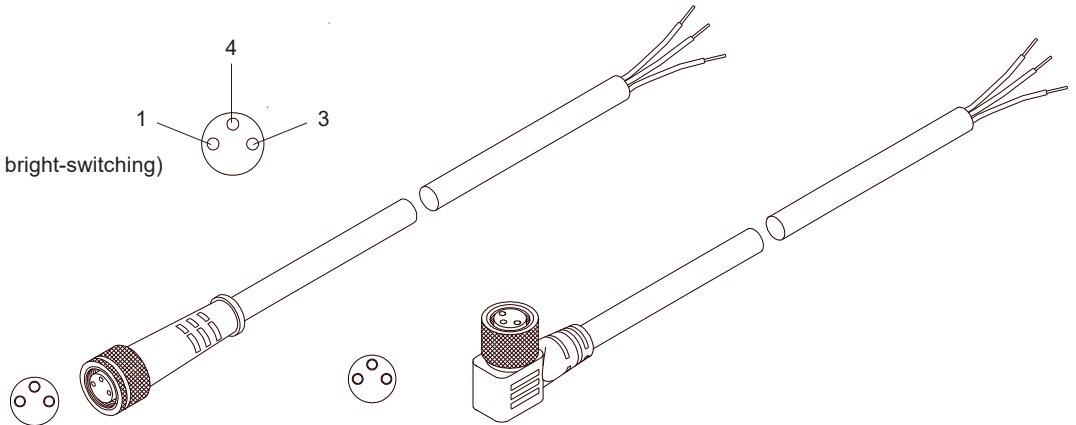
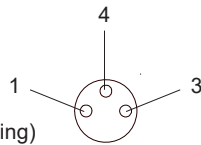

cab-M8/3-g...

cab-M8/3-w...