

# A-LAS Series

## ▶ AGL4-...-HS-500kHz-24V\_LED

(with adjustment LED)

- For control of A-LAS analog laser light barriers
- Digital output static (+Ub/0V) and digital output dynamic (10ms, +Ub/0V)
- Threshold correction can be activated via jumper
- High switching frequency (typ. 500 kHz)
- Analog output (0V ... +10V)
- Analog output (4 ... 20mA)
- High analog bandwidth (500 kHz for voltage output, 100 kHz for current output)
- High accuracy triggering
- Detection of smallest objects (starting from 10 µm)
- Dirt accumulation indication and compensation
- Switching state indication dynamic

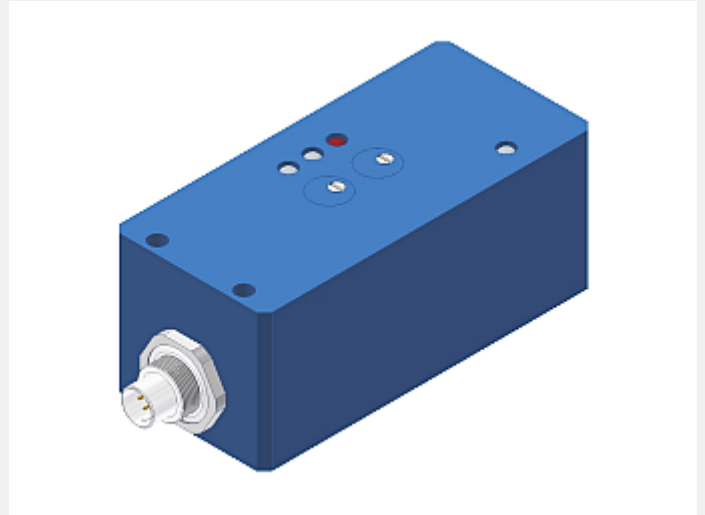

Design

### Product name:

**AGL4-Q-HS-500kHz-24V\_LED**  
**AGL4-Qinv-HS-500kHz-24V\_LED**

Q = NPN dark-switching (NPN normally open) /  
 PNP bright-switching (PNP normally closed)

Qinv = NPN bright-switching (NPN normally closed) /  
 PNP dark-switching (PNP normally open)

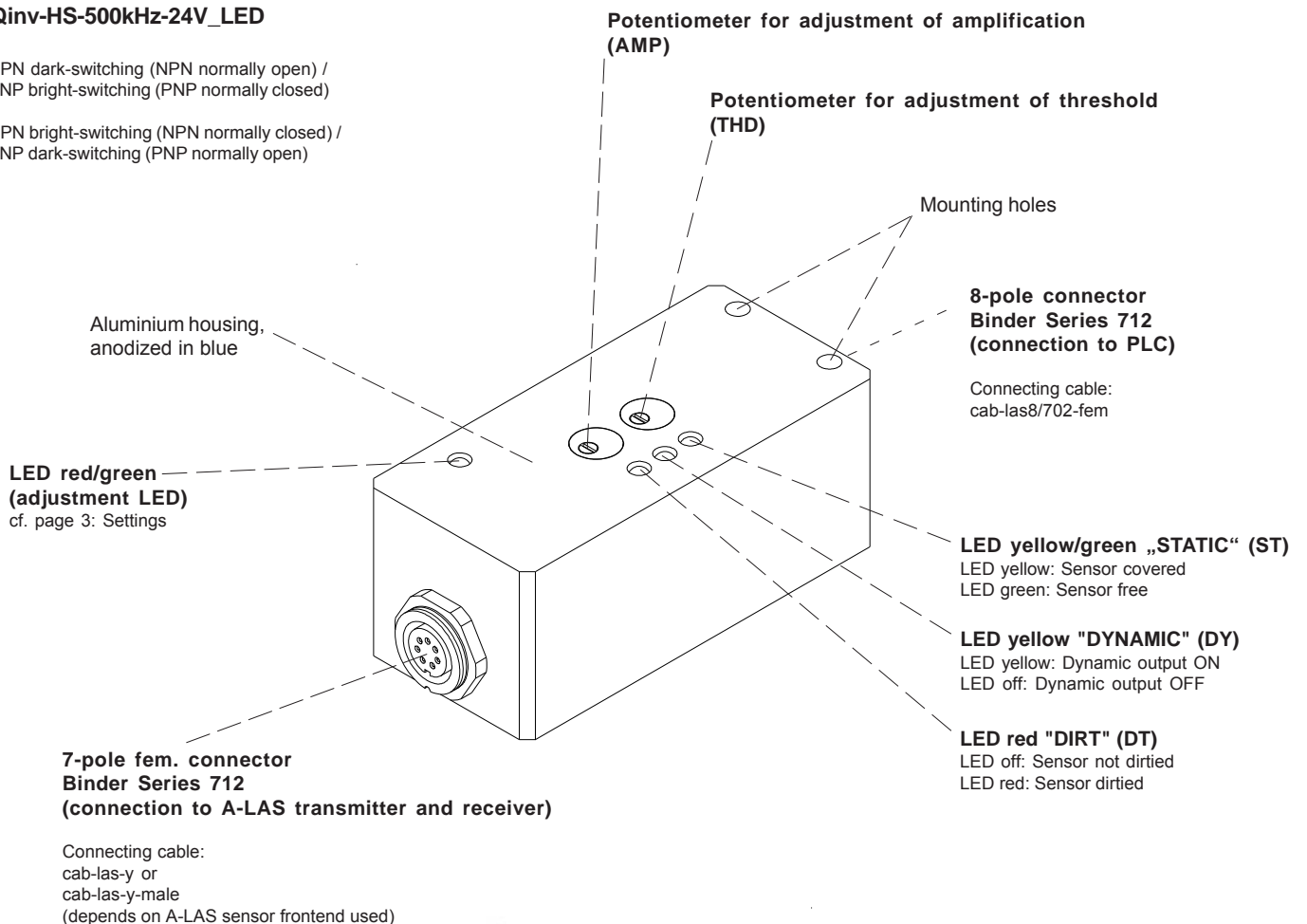



**Technical Data**

Model	AGL4-...-HS-500kHz-24V_LED (with adjustment LED)
Voltage supply	+24VDC $\pm$ 10%, reversed polarity protected, short-circuit protected
Current consumption	with A-LAS sensor: typ. 80 mA (unloaded outputs)
Operating temperature range	-20°C ... +60°C
Storage temperature range	-20°C ... +85°C
Trigger accuracy	< 1µm (depends on the aperture used with A-LAS sensor, and activated threshold correction)
Min. detectable object	starting from 10 µm (depends on the aperture of the A-LAS sensor frontend)
Housing material	aluminum, anodized in blue
Housing dimensions	LxWxG approx. 65 mm x 27 mm x 30 mm
Type of protection	IP 64
Threshold correction	adjustable by means of integrated jumper
Output ANALOG (voltage)	0V ... +10V cutoff frequency 500 kHz (-3dB)
Output ANALOG (current)	4 ... 20mA cutoff frequency 100 kHz (-3dB)
Output DIGITAL STATIC	1x Q and 1x Qinv: low 0V, high +Ub Q = npn dark-switching (npn normally open) / pnp bright-switching (pnp normally closed) Qinv = npn bright-switching (npn normally closed) / pnp dark-switching (pnp normally open)
Output DIGITAL DYNAMIC	1x dynamic (pulse length 10 ms): low 0V, high +Ub AGL4-Q-HS-500kHz-24V: npn dark-switching (npn normally open) / pnp bright-switching (pnp normally closed) AGL4-Qinv-HS-500kHz-24V: npn bright-switching (npn normally closed) / pnp dark-switching (pnp normally open)
Potentiometer for adjustment of gain	3-revolutions-potentiometer integrated in the housing
Potentiometer for adjustment of trigger threshold	3-revolutions-potentiometer integrated in the housing
Dirt accumulation LED (DT)	LED red (LED red = sensor dirtied, LED off = Sensor not dirtied)
Switching state LED DYNAMIC (DY)	LED yellow (LED yellow = dynamic output ON, LED off = dynamic output OFF) LED red/green (red = object is moving through sensor, green = no object is moving through sensor)
Switching state LED STATIC (ST)	LED yellow/green (LED yellow = object is moving through sensor, green = no object is moving through sensor)
Adjustment LED (alignment aid)	LED red/green (LED red = transmitter and receiver not aligned, LED green = sensor ready for operation, also cf. adjustment procedure)
Type of connector	Connection to the PLC: 8-pole connector Binder Series 712 Connection to A-LAS sensor: 7-pole fem. connector Binder Series 712 with integrated cable
Connecting cables	Connecting cable to PLC: cab-las8/702-fem (suitable lengths: 1m, 2m, 3m, 5m) Connecting cable to A-LAS sensor: cab-las-y (standard length: 2m, available up to max. 25m)
Switching frequency	typ. 500 kHz
EMV test acc. to	DIN EN 60947-5-2

Dimensions

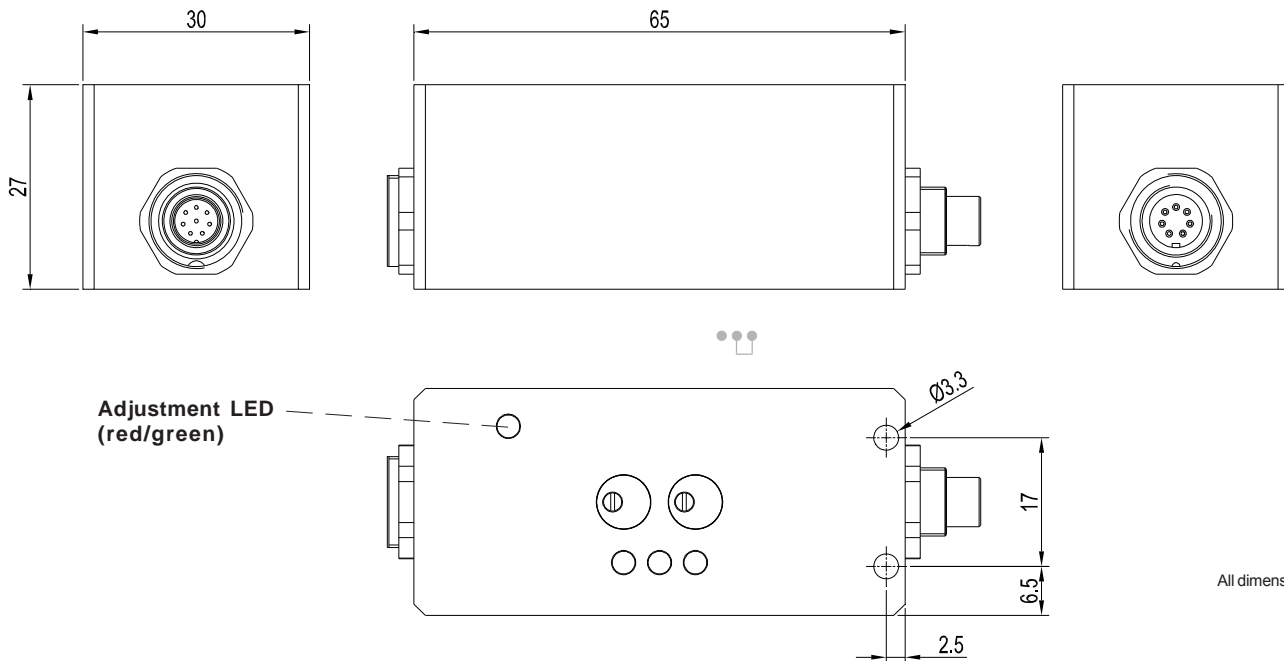

Settings

Potentiometer for adjustment of amplification (AMP)

Increase of analog signal:  
Rotation clockwise  
(3-revolutions-potentiometer)

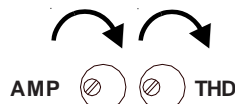

Potentiometer for adjustment of threshold (THD)

Increase of sensitivity  
Rotation clockwise  
(3-revolutions-potentiometer)

Jumper for adjustment of threshold correction (Jumper inside housing, under cap)

- Fix threshold (standard adjustment)
- Alternatively adjustable: Threshold correction TC (please open cap of housing to switch jumper)

LED yellow/green „STATIC“ (ST)  
LED yellow: Sensor covered  
LED green: Sensor free

LED yellow "DYNAMIC" (DY)  
LED yellow: Dynamic output ON  
LED off: Dynamic output OFF

LED red "DIRT ACCUMULATION" (DT)  
LED off: Sensor not dirtied  
LED red: Sensor dirtied

Adjustment procedure via the adjustment LED (LED red/green):

Step 1:  
Turn back the AMP potentiometer counter-clockwise up to the stop (when the zero point is reached it is signified by a small clicking noise).

Step 2:  
As long as transmitter and receiver are not adjusted, the adjustment LED lights red at the electronic control unit.  
Now adjust transmitter and receiver axial in a line in the required working distance in such a way that the laser spot is positioned in the middle of the receiver.  
As soon as transmitter and receiver are correctly aligned, the red adjustment LED switches off.

Step 3:  
Now adjust amplification via the AMP potentiometer by turning it clockwise until the adjustment LED lights green.

The laser light barrier now is ready for operation.

**Connector Assignment**

Connection AGL4-HS-500kHz-24V\_LED to A-LAS sensor frontend (transmitter and receiver):

7-pole fem. connector type Binder Series 712

Pin no.:	Assignment:
1	GND (0V)
2	+5V
3	not connected
4	+5V
5	ANALOG (0V ... +5V)
6	not connected
7	GND (0V)

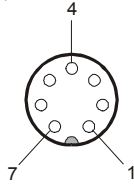

Connecting cable\*:  
cab-las-y-(length) or  
cab-las-y-male-(length)  
(standard length: 1m,  
also available lengths: 2m, 3m, 5m)

(\* type of connecting cable depends on which A-LAS sensor frontend is used)

Connection AGL4-HS-500kHz-24V\_LED to PLC:

8-pole connector type Binder Series 712

Pin no.:	(color of wire)	Assignment:
1	(white)	GND (0V)
2	(brown)	+Ub (+24VDC ± 10%)
3	(green)	ANALOG (4...20mA)
4	(yellow)	DIRT
5	(grey)	OUT (+Ub/0V)
6	(pink)	OUT/ (+Ub/0V)
7	(blue)	in case of AGL4-Q-HS-500kHz-24V: PULSE
		in case of AGL4-Qinv-HS-500kHz-24V: PULSE/
8	(red)	ANALOG (0V ... +10V)

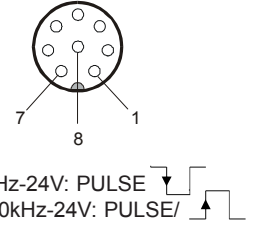

Connecting cable:  
cab-las8/702-fem-(length)  
(standard length: 2m, max. available length: 25m)

**Connecting Cables**

Connecting cable  
AGL4-... to A-LAS sensor frontend

cab-las-y-(length) or  
cab-las-y-male-(length)

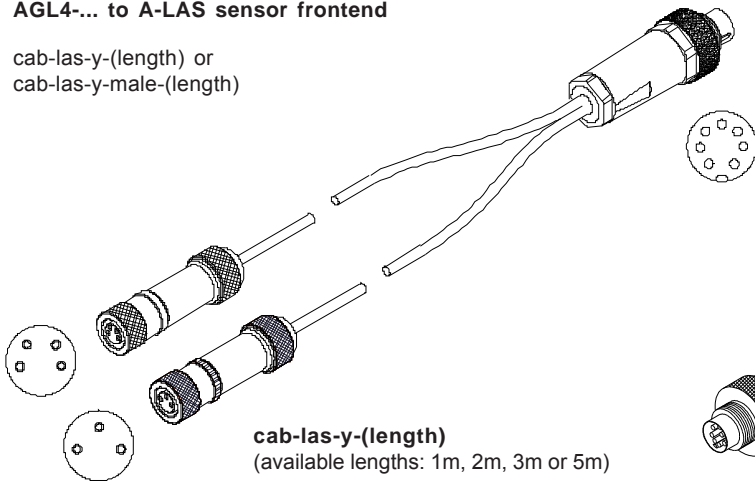

**cab-las-y-(length)**  
(available lengths: 1m, 2m, 3m or 5m)

**cab-las-y-male-(Länge)**  
(available lengths: 1m, 2m, 3m or 5m)  
suitable for A-LAS-50, A-LAS-75, A-LAS-100

Connecting cable  
AGL4-... to PLC

cab-las8/702-fem-(length)

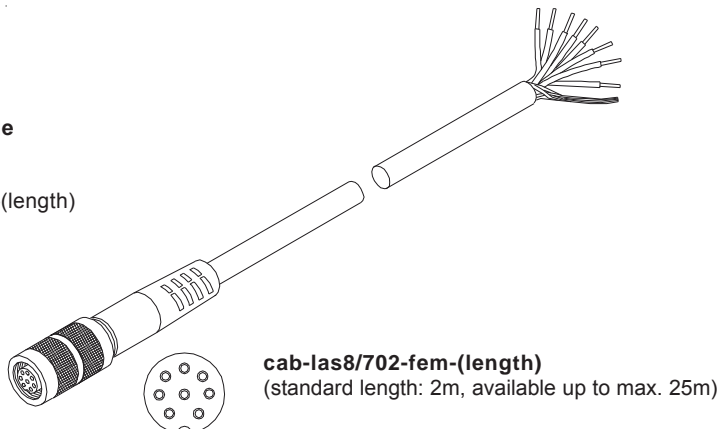

**cab-las8/702-fem-(length)**  
(standard length: 2m, available up to max. 25m)