

# FLB Series

## ► FLB-CON1 Electronic control unit

- Suitable for FLB-F, FLB-H, FLB-V sensors (FLB Series) as well as for FKB-...-P and SLB-...-P sensors (TLB Series)
- Detection of smallest objects (< 50 µm)
- Analog output (0V ... +10V) available
- Adjustment of sensitivity and pulse length by means of 5-step switches
- Switching state indication by means of red/green LED
- Dirt accumulation indication by means of yellow LED
- Switching frequency typ. 1 kHz



**Design**

**Product name:**

- FLB-CON1-Q**
- FLB-CON1-Qinv**
- FLB-CON1-Q-ANA**
- FLB-CON1-Qinv-ANA**

**Please note:**  
The frame light barriers **FLB-F-50/...**, **FLB-F-60/60**, **FLB-F-100/100**, **FLB-H-50**, **FLB-V-50**, **FLB-V-60**, **FLB-V-100** are not suitable for use with **FLB-CON1-...**

Q = Switching output:  
PNP bright-switching (PNP n.c.)  
NPN dark-switching (NPN n.o.)

Qinv = Additional switching output:  
PNP dark-switching (PNP n.o.)  
NPN bright-switching (NPN n.c.)

ANA = Analog output (0 ... +10V)

Suitable for the connection of sensor frontends of type:

- FLB-F-...**
- FLB-H-...**
- FLB-V-...**
- FKB-...-P**
- SLB-...-P**

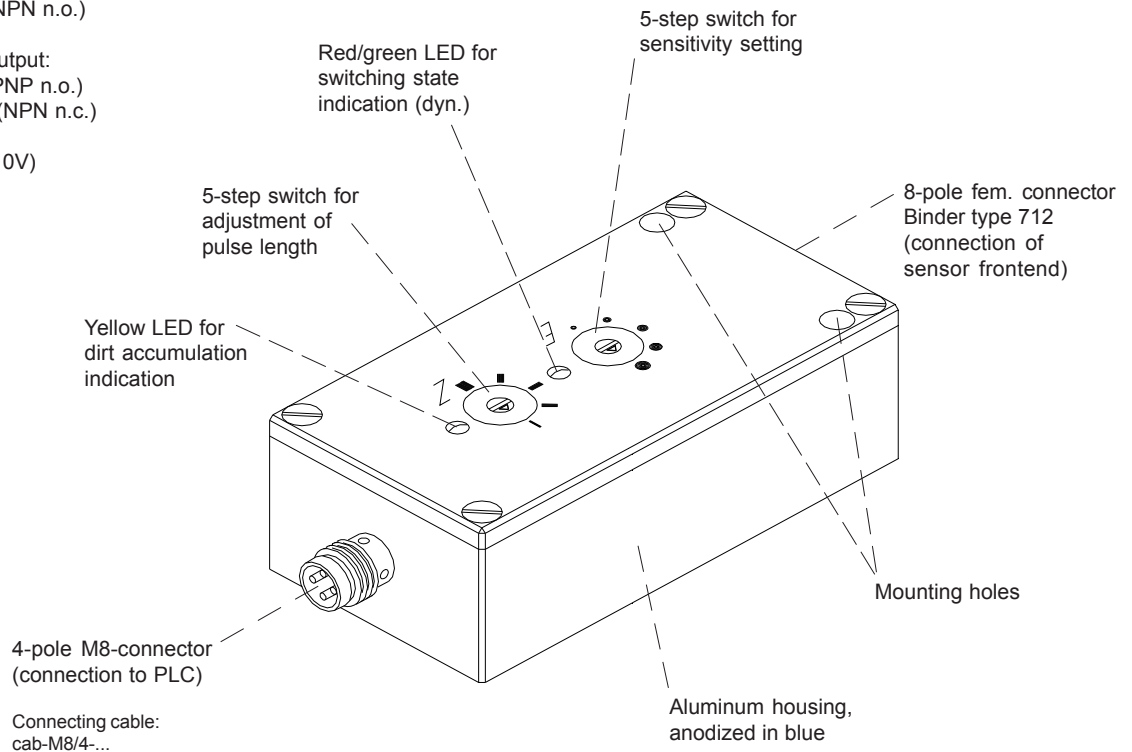



**Technical Data**

Model	FLB-CON1
Voltage supply	+12VDC ... +32VDC, reverse-polarity protected, overcurrent protected
Current consumption	with sensor: typ. 80 mA
Operating temperature range	-20°C ... +60°C
Storage temperature range	-20°C ... +85°C
Housing dimensions	LxWxH approx. 70 mm x 36 mm x 24 mm
Housing material	Aluminum, anodized in blue
Enclosure rating	IP 64
Digital output	Q: PNP bright-switching (PNP n.c.), NPN dark-switching (NPN n.o.) / Qinv: PNP dark-switching (PNP n.o.), NPN bright-switching (NPN n.c.)
Analog output	optional (0V ... +10V)
Dirt accumulation indication	by means of a yellow LED
Switching state indication	by means of a bicolor LED (red/green): red: Object passes through light curtain green: Light curtain is free (respectively no change)
Pulse lengthening	in 5 steps by means of step switch (20 ms ... 300 ms)
Sensitivity setting	in 5 steps by means of step switch
Type of connector	4-pole M8-connector (connection to PLC)
Switching frequency	typ. 1 kHz
Max. switching current	200 mA, short circuit proof
EMC test acc. to	DIN EN 60947-5-2

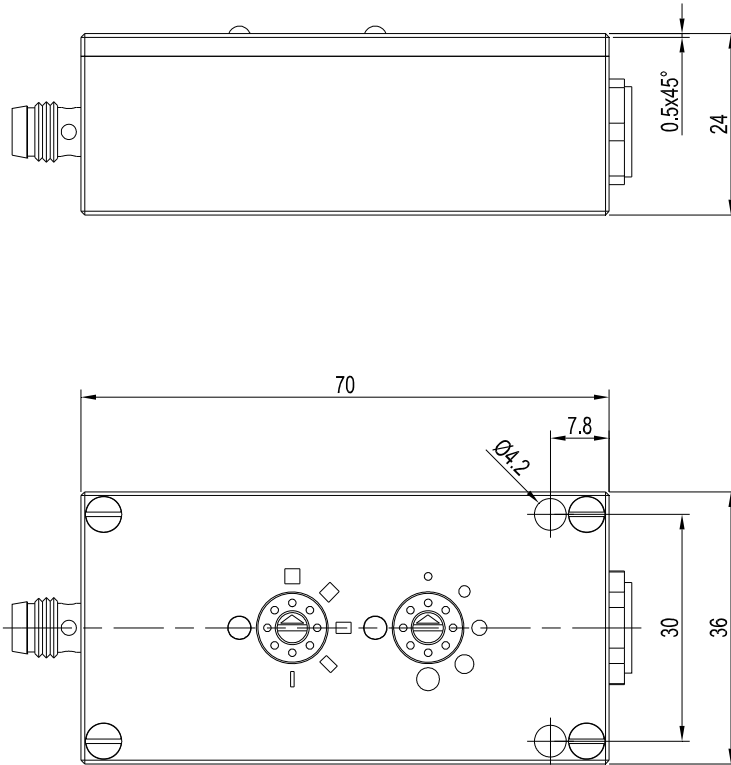

**Dimensions**



(All dimensions in mm)



**Connector Assignment**

**Connector assignment for FLB-CON1:**

**4-pole M8-connector  
(connection to PLC)**

Pin No.:	Assignment:	Color:
1	+Ub (+12VDC ... +32VDC)	brown
2	with <b>FLB-CON1-Q</b> : n.c. with <b>FLB-CON1-Qinv</b> : n.c. with <b>FLB-CON1-Q-ANA</b> : ANALOG (0V ... +10V) with <b>FLB-CON1-Qinv-ANA</b> : ANALOG (0V ... +10V)	white
3	GND (0V)	blue
4	with <b>FLB-CON1-Q</b> : Output DYN with <b>FLB-CON1-Qinv</b> : Output INV DYN with <b>FLB-CON1-Q-ANA</b> : Output DYN with <b>FLB-CON1-Qinv-ANA</b> : Output INV DYN	black

**8-pole female connector Binder series 712  
(connection to FLB-F, FLB-H, FLB-V, TLB, SIA)**

Pin No.:	Assignment:
1	Shield
2	Shield
3	Transmitter anode
4	Phototransistor collector
5	Transmitter cathode 1
6	Phototransistor emitter
7	Transmitter cathode 2
8	n.c.

**Please note:**  
The frame light barriers **FLB-F-50/...**,  
**FLB-F-60/60**, **FLB-F-100/100**, **FLB-H-50**,  
**FLB-V-50**, **FLB-V-60**, **FLB-V-100** are not  
suitable for use with **FLB-CON1-...**

**Connecting Diagram**

For connection to electronic control unit FLB-CON1-..., the following sensor frontends are suitable:

**Please note:**  
 The frame light barriers **FLB-F-50/...**,  
**FLB-F-60/60**, **FLB-F-100/100**, **FLB-H-50**,  
**FLB-V-50**, **FLB-V-60**, **FLB-V-100** are **not**  
 suitable for use with FLB-CON1-...

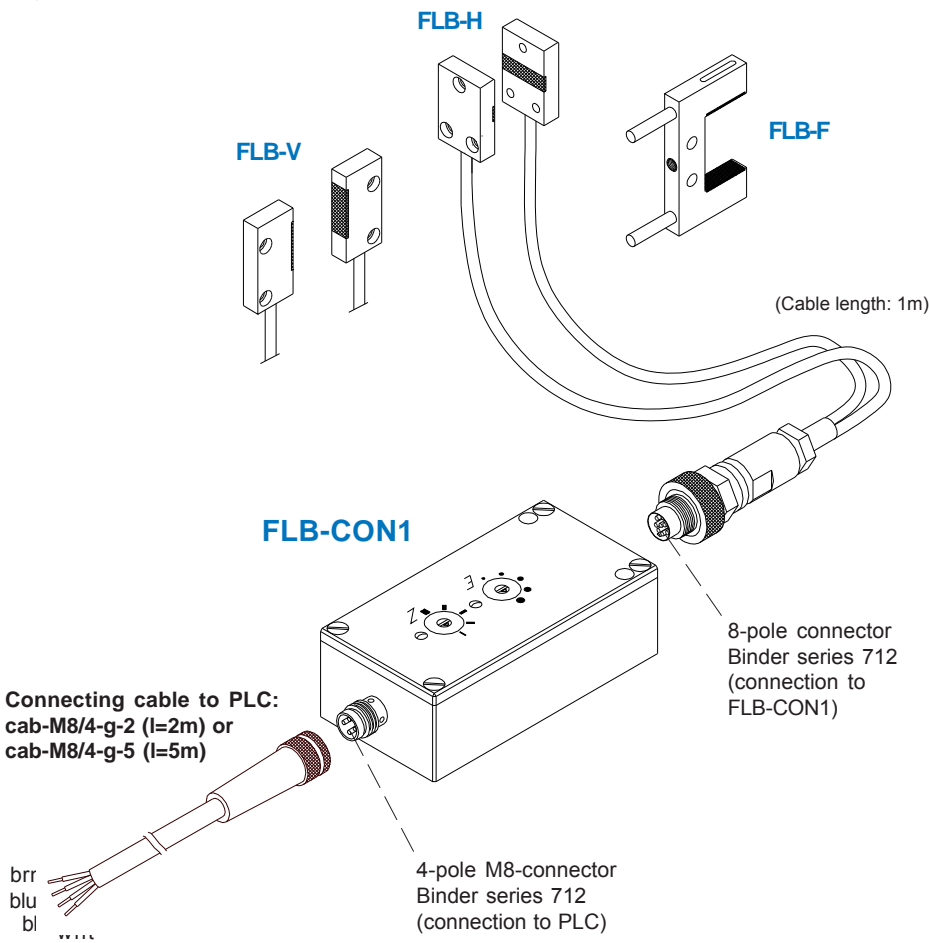

FKB-06-...-P

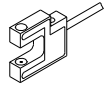

FKB-06-...-BL-P

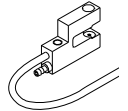

FKB-08-...-P

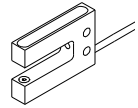

FKB-08-...-BL-P

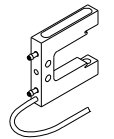

SLB-01-P

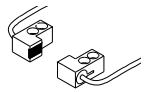

SLB-02-P

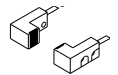

SLB-03-P

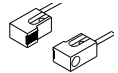

SLB-04-P



SLB-05-P

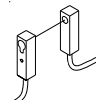

SLB-06-P

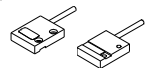

SLB-08-P

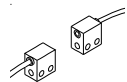



**Setting**

**Sensitivity setting (step-switch „E“):**

Sensitivity can be adjusted by means of a step-switch. The term 'sensitivity' defines the minimum detectable part size. The sensitivity can be adjusted in 5 steps.

**Adjustment of pulse lengthening (step-switch „Z“):**

The pulse length of the dynamic output can be adjusted by means of a step-switch. 5 pulse lengths are available.

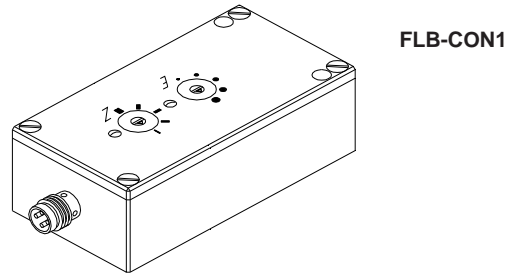
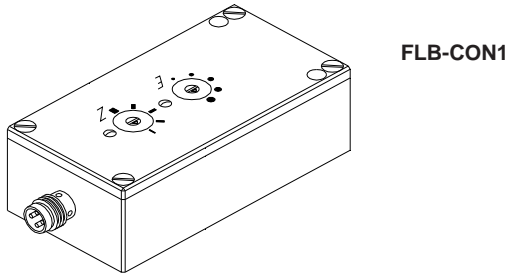

	Step	Part size (dyn.)	Part size (stat.)
	1	$\geq 0.5$ mm	$\geq 2$ mm
	2	$\geq 0.7$ mm	$\geq 3$ mm
	3	$\geq 1.3$ mm	$\geq 5$ mm
	4	$\geq 1.7$ mm	$\geq 7$ mm
	5	$\geq 2.5$ mm	$\geq 10$ mm

	Step	Pulse length
	1	300 ms
	2	200 ms
	3	100 ms
	4	50 ms
	5	20 ms

**Dirt accumulation display (yellow LED):**

The user is informed about the dirt accumulation status by means of a yellow LED. If this yellow LED lights up, the transmitter or receiver side should be checked for dirt.

**Switching state display (red/green LED):**

The switching state is indicated by a red/green LED. In case that a measuring object is detected, the LED changes from GREEN to RED. The two-color-LED is coupled to the dynamic output, i.e. after pulse end the LED returns to its starting state = GREEN.

