

# M-LAS Series

## ► M-CON4 Electronic control unit

- For control of M-LAS sensors
- 2 digital outputs (Q and Qinv)
- High precise triggering in  $\mu\text{m}$  range
- Switching state indication by means of a bicolor-LED
- Potentiometer for sensitivity setting
- Switching frequency typ. 10 kHz
- Sturdy aluminum housing
- 4-pole M12 connector (connection to PLC)

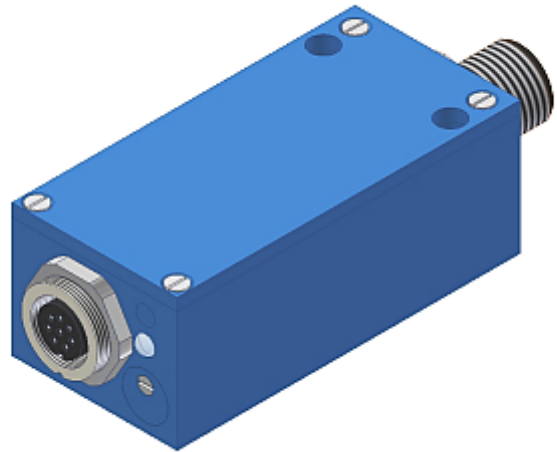

Design

**Product name:**

**M-CON4**

Mounting holes

Sturdy aluminum housing,  
anodized in blue

**8-pole female connector**  
Binder Series 712

Connection to sensors of M-LAS Series  
with 8-pole connector Binder Series 712:  
M-LAS-3-P  
M-LAS-4/90-P  
M-LAS-M4-P  
M-LAS-M8-P  
M-LAS-Q5/90-P

**LED yellow/green**  
LED yellow: Sensor covered  
LED green: Sensor free

**Potentiometer for  
sensitivity setting**  
Rotation clockwise:  
Increase of sensitivity  
(decrease of transmitting power)

**4-pole M12 connector**  
(connection to PLC)

Connecting cable:  
cab-M12/4-g-2



**Technical Data**

Model	M-CON4
Voltage supply	+12VDC ... +32VDC Ripple 10% max.
Current consumption	with M-LAS sensor: typ. 80 mA
Operating temperature range	-20°C ... +60°C
Storage temperature range	-20°C ... +85°C
Triggering accuracy	typ. < 1 µm
Min. detectable object	starting from 10 µm
Housing	Aluminum, anodized in blue, dimensions: approx. 54 mm x 26 mm x 21 mm (without connector)
Enclosure rating	IP 64
Output DIGITAL	Pin 2: Qinv: NPN bright-switching (NPN n.c.) / PNP dark-switching (PNP n.o) Pin 4: Q: PNP bright-switching (PNP n.c.) / NPN dark-switching (NPN n.o.)
Potentiometer for sensitivity setting (gain factor)	3-revolutions potentiometer integrated in the M-CON8 housing
Switching state indication	LED yellow/green (yellow = sensor covered, green = sensor free)
Type of connector	Connection to PLC: 4-pole M12 connector Connection to M-LAS sensor: 8-pole connector Binder Series 712
Modulation frequency	typ. 100 kHz
Switching frequency	typ. 10 kHz
Max. switching current	200 mA, overcurrent-protected
EMC test acc. to	DIN EN 60947-5-2

Dimensions

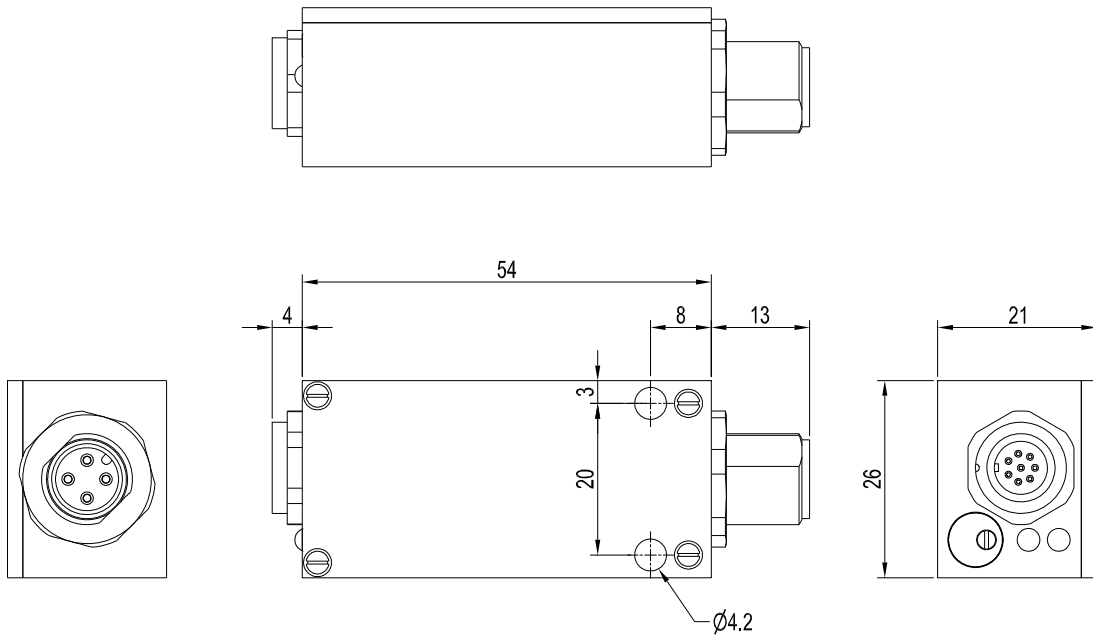

All dimensions in mm

Setting

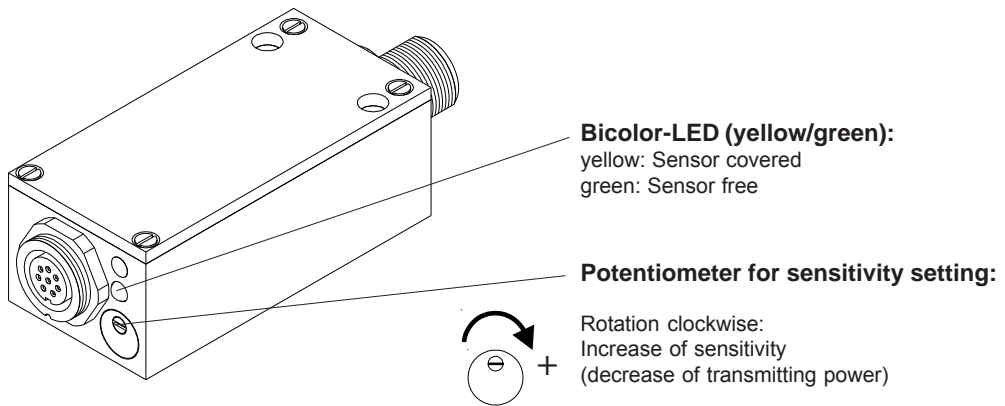

Connector Assignment

**8-pole Buchse Typ Binder Serie 712**  
(to M-LAS-...-P sensor):

Pin No.:	Assignment:
1	0V (GND)
2	+5V
3	n.c.
4	Output receiver (/AC)
5	n.c.
6	n.c.
7	Transmitter anode
8	Transmitter cathode

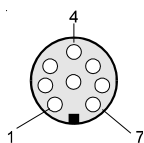

**4-pole M12 connector**  
(to PLC):

Pin No.:	Color:	Assignment:
1	brn	+Ub (+12VDC ... +30VDC)
2	wht	Output Q
3	blu	0V (GND)
4	blk	Output Qin

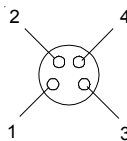

**Connecting cable to PLC:**  
cab-M12/4-g-2 (l = 2m)



Laser Light Barriers

**Sensor frontends (laser light barriers)**  
suitable for operation with M-CON4 electronic control unit

M-LAS-4/90-P

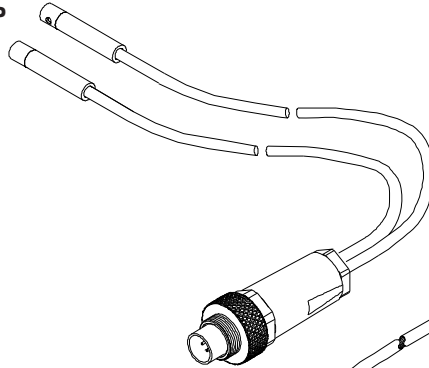

M-LAS-3-P

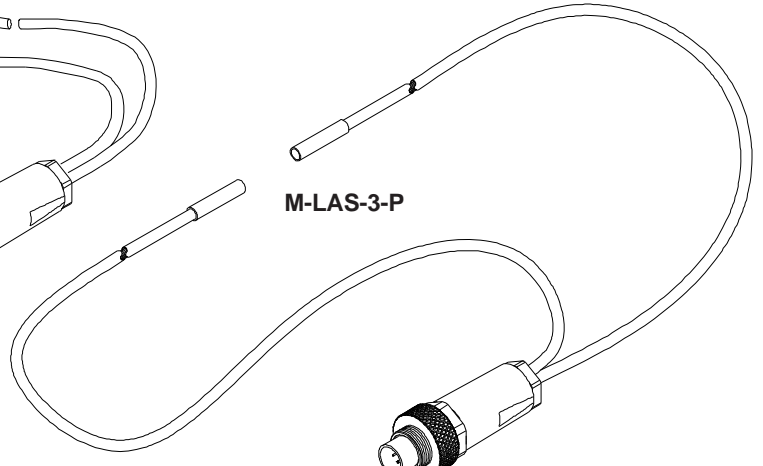

M-LAS-M4-P

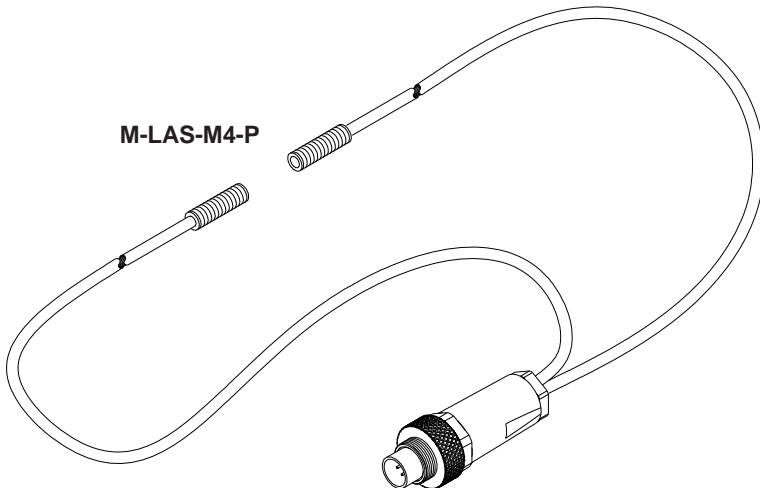

M-LAS-Q5/90-P

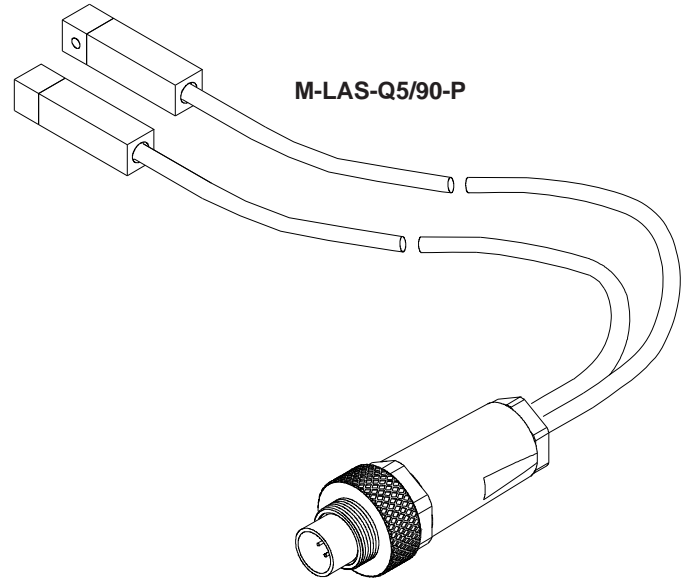

M-LAS-M8-P

